



# **CABLE AND PIPE LOCATOR SUCCESS AG-309.15 N**

**TECHNICAL DESCRIPTION  
OPERATING INSTRUCTIONS**

## Table of Contents

<b>Introduction</b> .....	3	10.1. <i>The work with the receiver in the mode «Selection of the cable from a bunch»</i> ..	32
<b>1. Appearance of Receiver</b> .....	4	10.2. <i>«Hot» keys for the work in the mode «Selection of the cable from the bunch»</i>	34
<b>2. OPERATING MODES</b> .....	5	<b>11. Mode «Search of defects» using external sensors</b> .....	35
2.1 <i>“Route” mode</i> .....	5	11.1. <i>The work with the receiver in the mode «Search for defects»</i> .....	35
2.2 <i>«Graphic» mode</i> .....	6	11.2. <i>«Hot» keys for work in the «Graphic» mode with DODK and DK1</i> .....	39
2.3 <i>«Graphic+» mode</i> .....	6	<b>Appendix 1</b> .....	40
2.4 <i>«Minimum maximum»</i> .....	7	<b>Appendix 2</b> .....	41
2.5 <i>Modes with graphic representation of “Relative distance to the Utility”(R.dist.)</i> .....	7	<b>Appendix 3</b> .....	45
2.5.1 <i>“R.dis. Graph” mode</i> .....	8	<b>Appendix 4</b> .....	47
2.5.2 <i>«MIN&amp;R.Dist» mode</i> .....	9	<b>12. Transmitter AG-105</b> .....	49
2.6 <i>«2 frequencies» mode window</i> .....	9	12.1. <i>Purpose of use and physical configuration</i> .....	49
<b>3. Receiver menu description</b> .....	11	12.2. <i>Control and indication elements</i> .....	50
3.1. <i>Receiver switching on and menu call</i> ..	11	12.3. <i>Ways of external commutation</i> .....	53
3.2. <i>The general view of the menu screen</i> ..	11	12.4. <i>Accessories</i> .....	53
3.3. <i>Menu parameter selection</i> .....	11	12.5. <i>Design and function</i> .....	54
<b>4. Start of work</b> .....	16	12.6. <i>Illustrative use information about «Power supply monitoring», «Buttons functionality», «Symbols»</i> ..	55
<b>5. Search of cables in the mode «Route»</b> ..	17	12.7. <i>«Multimeter» of the output parameters</i> .....	55
5.1. <i>Cable location in the passive mode</i> ...	17	12.8. <i>Sound signals</i> .....	56
5.2. <i>Search of a communication and measurement of its burial depth</i> .....	18	<b>13. Working with the device</b> .....	56
5.3. <i>Cable route location in the active mode</i> .....	20	13.1. <i>Preparatory activities</i> .....	56
<b>6. Search of communications in the mode «Graphic»</b> .....	23	13.2. <i>Settings</i> .....	59
6.1. <i>Setting of the receiver for work in the «Graphic» mode</i> .....	23	13.3. <i>Clips</i> .....	59
6.2. <i>«Hot» keys for work in the «Graphic» mode</i> .....	25	13.4. <i>Internal transmitting inductor «In»</i> ...	60
6.3. <i>Search of communications in the mode «Graphic»</i> .....	26	13.5. <i>External induction transmitting antenna</i> .....	60
<b>7. Search of the utilities in the mode «Graphic+»</b> .....	27	13.6. <i>Transmitting induction “clamp”</i> .....	60
7.1. <i>Setting of the receiver for work in the «Graphic+» mode</i> .....	27	13.7. <i>External power sources</i> .....	60
7.2. <i>Search of communications in the mode «Graphic+»</i> .....	27	13.8. <i>Electromagnetic compatibility</i> .....	60
<b>8. Performing the cable location in the mode «MIN &amp; MAX»</b> .....	29	13.9. <i>Ingress protection rating</i> .....	60
<b>9. Performing cable route location in the mode «2 frequencies»</b> .....	29	<b>14. Transmitter direct connection to utility</b> .....	61
<b>10. The work mode «Cable selection from a bunch»</b> .....	32	<b>Appendix 5</b> .....	62
		<b>Appendix 6</b> .....	64

## Introduction

This operation manual contains a description of the cable and pipe locator Success AG-309.15N, its working modes and the information necessary for its proper use. The basic set consists of the receiver and a tracing transmitter. The receiver can be used individually or with the transmitter. The receiver works at the network frequencies 50(60) Hz, 100(120) Hz, and with route locating transmitters at frequencies of 512Hz, 1024 Hz, 8192 Hz, 32768 Hz (33 kHz).

### AG-309.15N is used for:

- Detection of cables and metal pipelines underground up to 10 m;
- Direct digital measurement of the depth up to 10 m;
- Indication of the deviation from the communication axis in the mode "ROUTE";
- Measurement of the current in the cable;
- Survey the ground before the excavation works;
- Distance of tracing from the place of transmitter connection is up to 3 km.

Operation with optional equipment:

- Sensor "NR -117"
- Sensors DKI and DODK.

Searching of cable faults at shorting of its armoring to the ground

- Searching of outer insulation defects of metal pipelines (water, gas) at trenchless laying.
- Inductive clamps CI-105/110
- Identification of the cable, the function "selection the cable from a bunch"
- Non-contact connection to the pipelines or to the cable lines

### Intended use

- Power
- Public utilities
- Oil and gas industry
- Geodesy
- Communication
- Construction
- Other industries

### Operation conditions

- Ambient temperature, °C .....from -20C to +60
- Relative humidity, % .....up to 85 at t=35 °C
- Pressure, kPa,.....84 to 106
- Device protection class..... IP 54

### Receiver working principle

The cable and pipe locator's Success AG-309.15N working principle is based on the analysis of the electromagnetic field, created by the presence of alternating current flowing through underground services. The electrical signals induced in the receiver sensors are amplified, filtered, processed by the processor and then displayed on the graphical display in the form of the utility's position line, linear scale, digital value of the signal level amplification coefficient, distance to the communication axis, the value of the current flowing through it, the graphic of the signal level change and other parameters.

Due to constant improvement of produced instruments, «NPO TECHNO-AC» LLC reserves the right to change schematics, software and user manuals, without degradation of performance characteristics for its devices, without preliminary notification. Separate changes in user manual content may be implemented after its reissue.

**Up-to-date information about all produced instruments is published on [www.technoac.com](http://www.technoac.com)**

## 1. Appearance, AP-019.1 receiver controls

AP-019.1 receiver is made in the solid cast IP54 body to the battery compartment the body provides the protection IP68, the device can be splitted in three components: the face panel with controls and displays, battery compartment and bottom part with the antenna block. There is external sensor connection port on the back side of receiver.

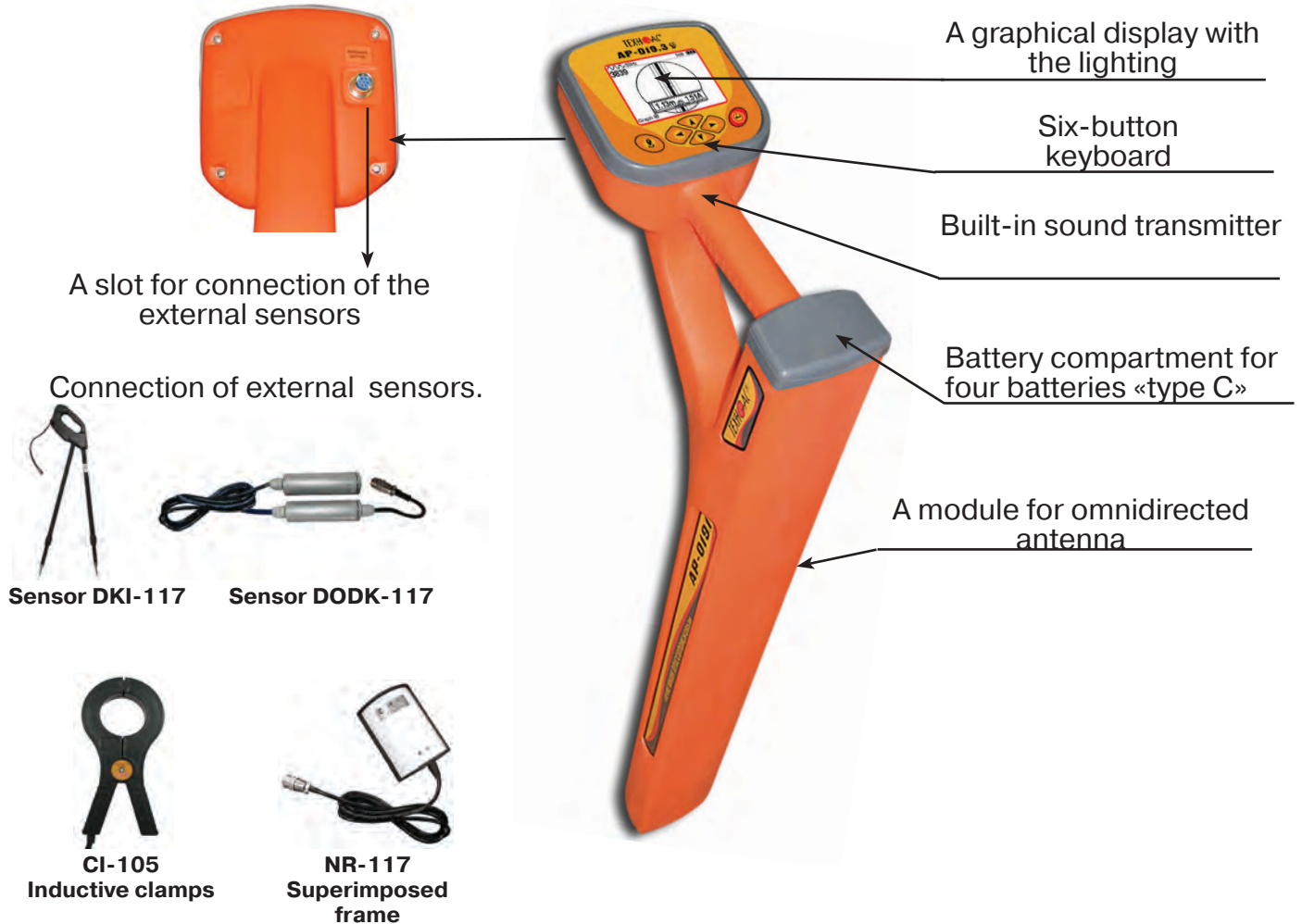

### Face panel, controls

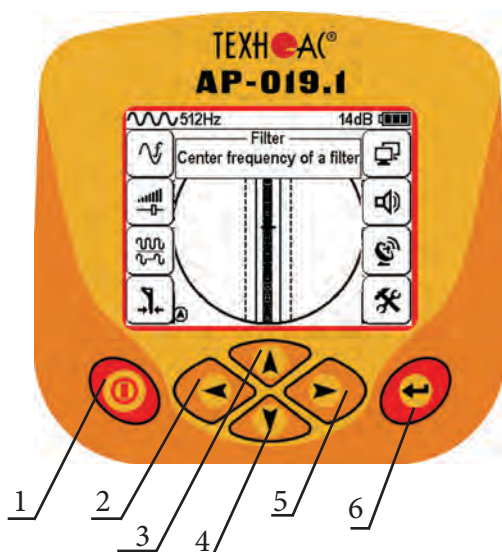

	«Power» button (1) Switching on/off the receiver
	«Enter» button (6) - calls out a menu, - enters into the editing mode of the selected menu option, - exit for the editing mode saving selected parameters.
	Buttons «Up» (3), «Down» (4), «Right» (5), «Left» (2). - selection of the menu option (icon), - selection or changing the parameter inside the menu, - operative change in the parameters

## 2. OPERATING MODES

### 2.1 "Route" mode

When turning on the receiver for the first time, the device will begin in route mode and the service information will appear. Route mode is the primary screen. Below, the indications are shown, which are dependent on the operator position near the located utility.

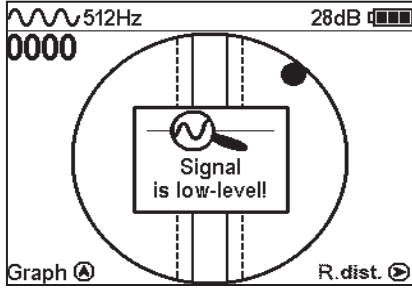

The receiver can't detect the utility.

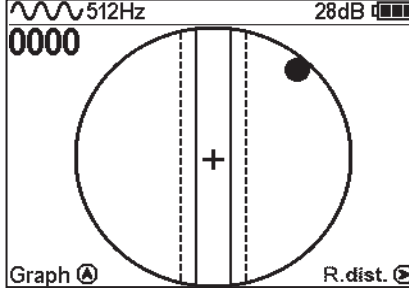

The ball on the screen shows the direction in which utility is located.

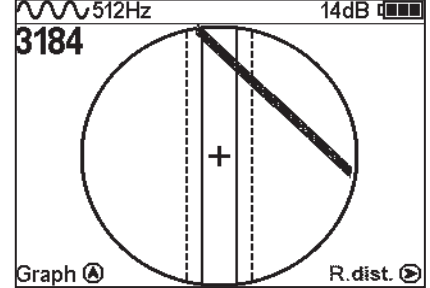

Position of utility axis shows, where the utility is situated.

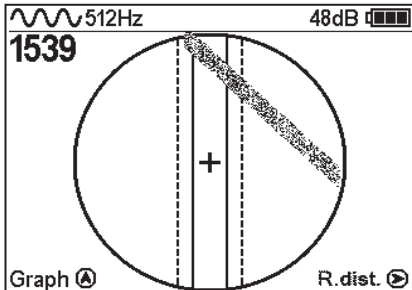

When approaching the utility, a blurred line indicates its position.

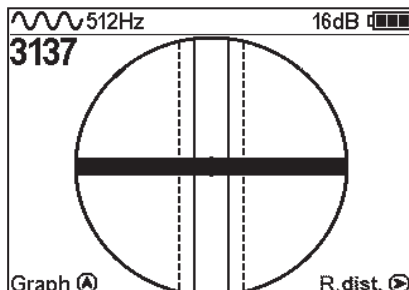

When above the utility, a solid line will appear which is perpendicular to the utility's direction.

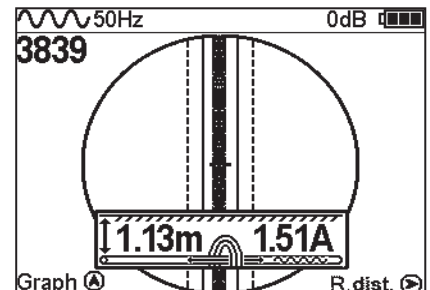

Depth and current measurement enable automatically, If the utility indicating line is aligned with the axis of the receiver.

### Route Mode Description

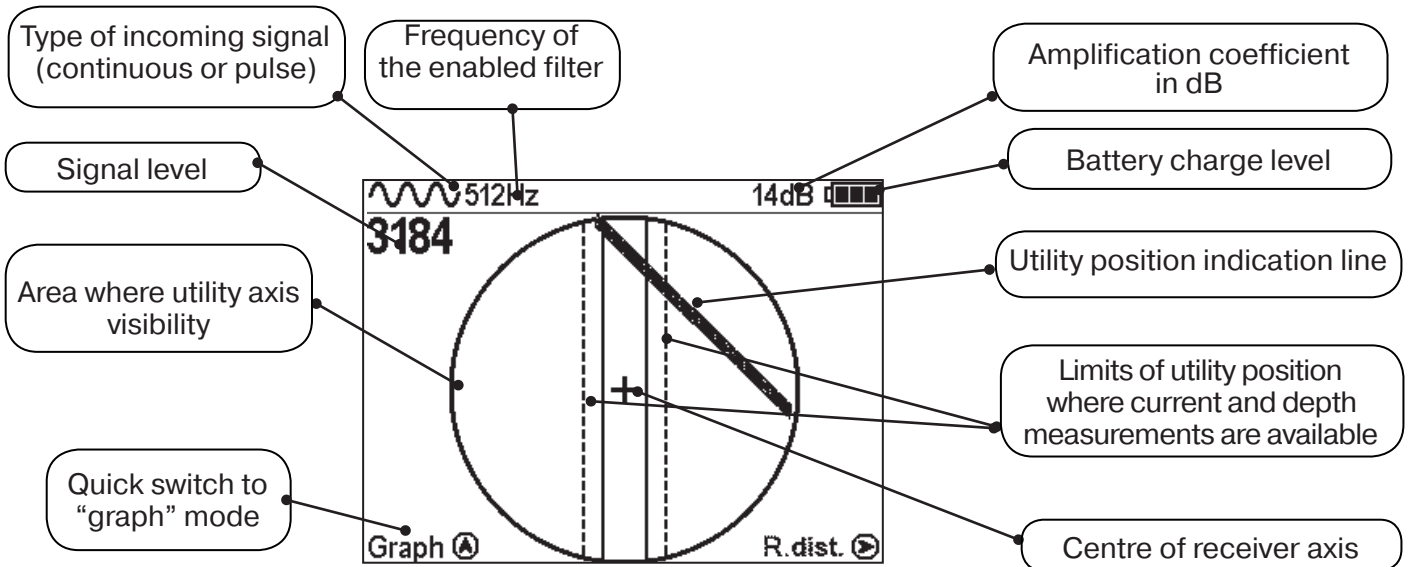

\* The four-digit number "signal level" (0000 - 4100) represents the intensity of the electromagnetic field, which is dependent on the filter frequency. The numeric value of the "signal level" becomes greater when an operator approaches the source of electromagnetic signal of the chosen frequency. The signal gains its maximum level when the receiver is placed strictly above the utility. The first number of four-digit figure represents the order of the three-digit figure, generated by other figures: 0 - x1, 1 - x10, 2 - x100, 3 - x1000, 4 - x10000. Dynamic range of changing signal levels is 1,000,000 times (120 dB).

## Route Mode and Depth Measurement

When the operator stands strictly above the utility and the line indicating the utility is positioned strictly in the centre field between the two dotted lines, an automatic depth and current measurement is performed.

**NOTE:** When performing a depth measurement, the receiver antenna should be positioned perpendicularly to the utility.

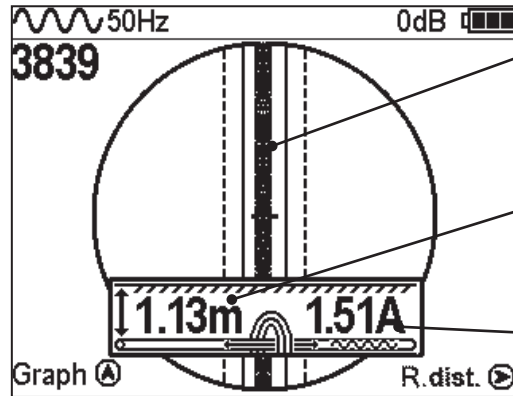

Receiver and utility axis are perfectly aligned

Buried depth of the utility

Current of the utility

## 2.2 Graphic Mode

In graphic mode, the receiver screen is split into two segments. The upper segment indicates utility position in 2D, and the lower segment is a moving graph of signal level change in time according to a "maximum" method, where a maximum signal is reached when the receiver is positioned strictly above the utility and signal decreases when the receiver is moved further away from it. In this mode, current and depth measurement function is not available.

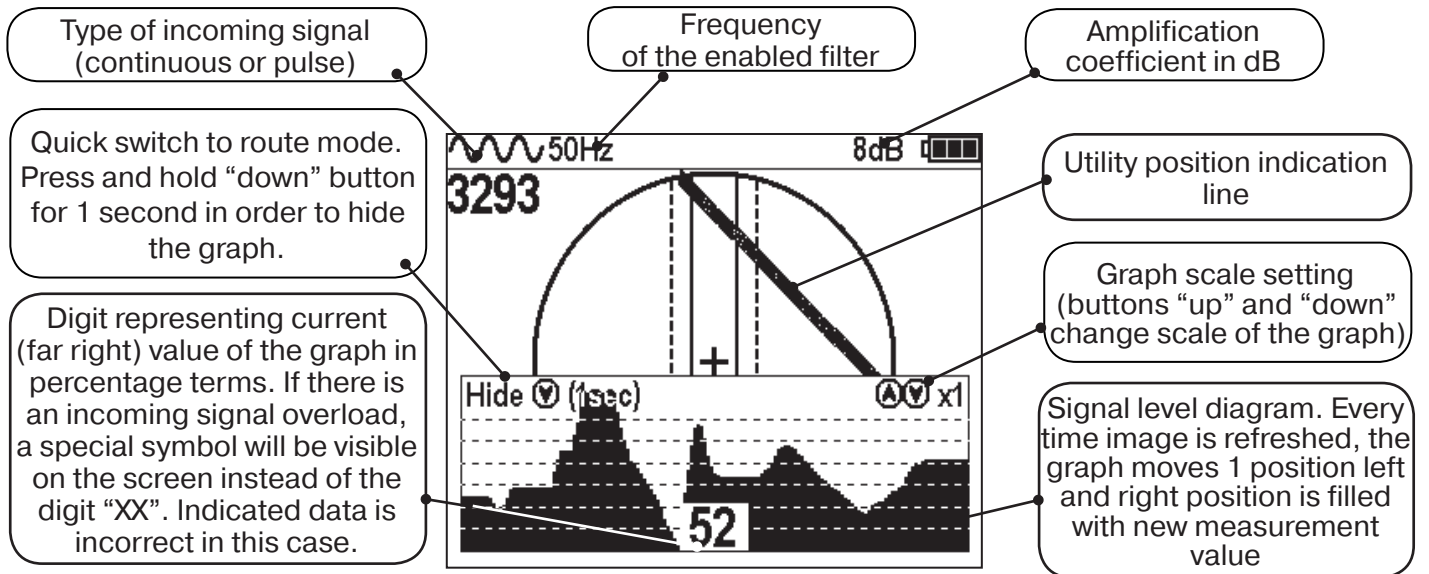

## 2.3 Graphic+ Mode

This mode is different from the ordinary graphic mode. The main difference is that the utility axis indication line represents only 50/60Hz utilities (power cables or utilities with induced signal) which can be accidentally met during the operation on active frequencies.

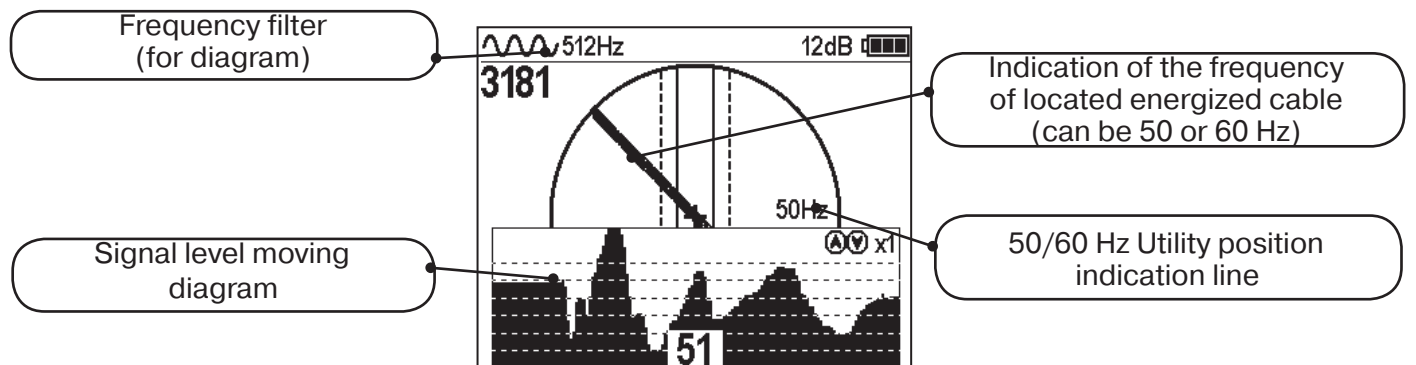

## 2.4 “Minimum maximum”

In “MIN & MAX” mode, the receiver screen is split into two segments. The upper segment is a moving diagram which represents signal level changes according to the “minimum” method – it means that the signal will be minimal when the receiver is positioned strictly over the utility. If the receiver is moved aside, the signal level will increase.

The lower segment represents the “maximum” method diagram – the signal will be maximal if the receiver is positioned strictly over the utility, and it will decrease if the device is moved further away.

This mode does not allow depth and current measurements.

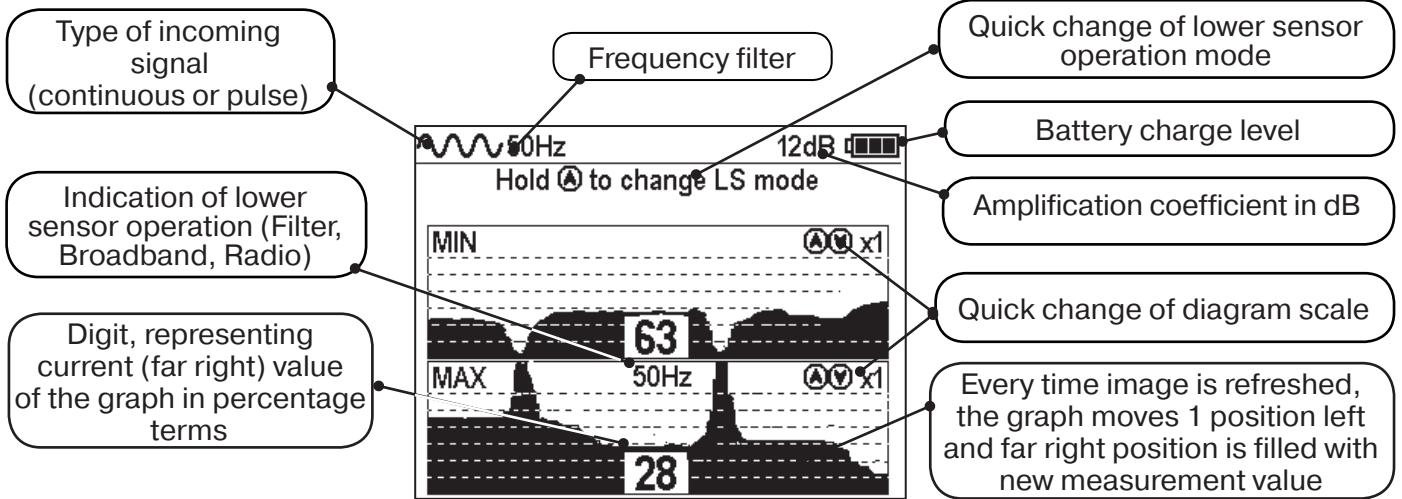

## 2.5 Modes with Graphic Representation of “Relative distance to the Utility” (R.dist.)

In cases given above, both utilities lay beside each other. However, in this case “MIN & MAX” mode does not allow the user to measure the depth of these cables. For this reason, it is better to use graphic modes with indication of the “relative distance to the utility”.

While approaching the utility, the value of “relative distance to the utility” changes in the way described on pictures, shown below:

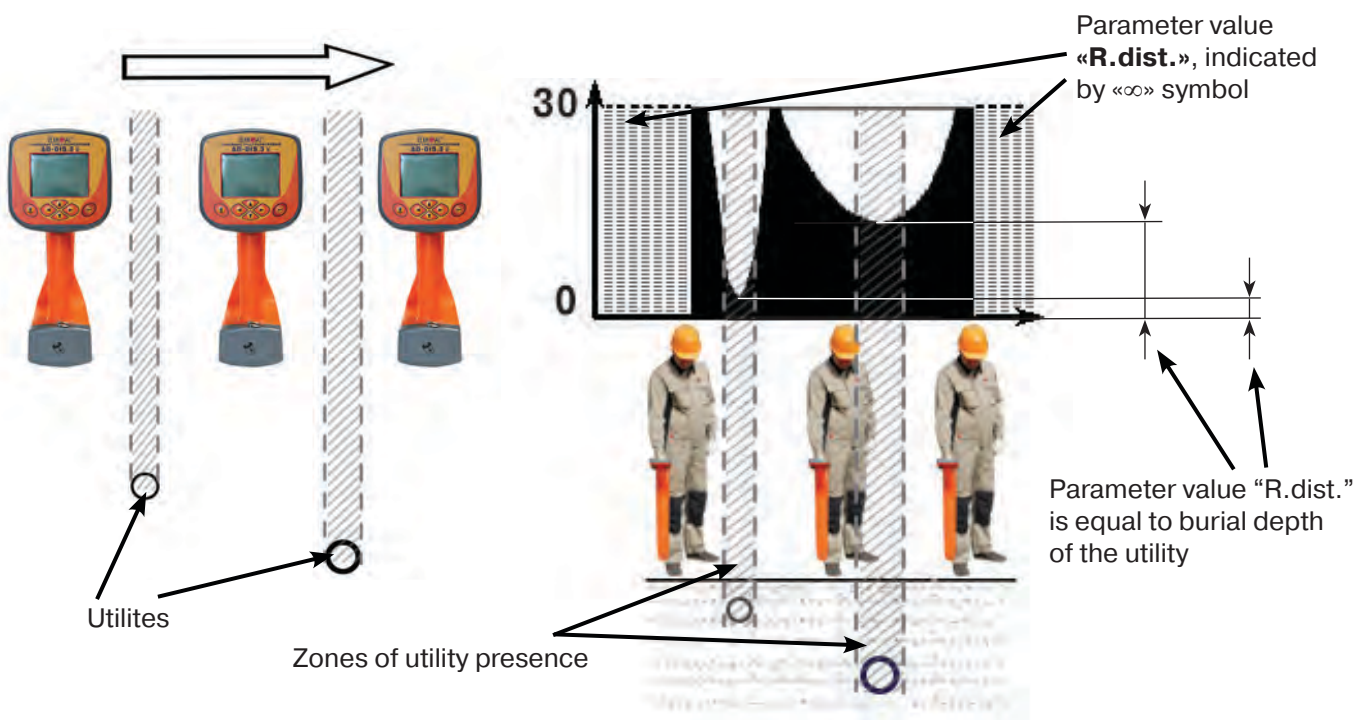

This parameter can have values from “0.01” to “30.00”, “>30” and “∞”. Value “∞” are indicated when the receiver is positioned aside from the utility or when the utility is positioned above the receiver (an example being when there are overhead voltage lines around). The parameter “relative distance to the utility” will have its minimum value when the receiver is positioned directly above the utility axis. In this case, this value is equal to the real burial depth of the utility.

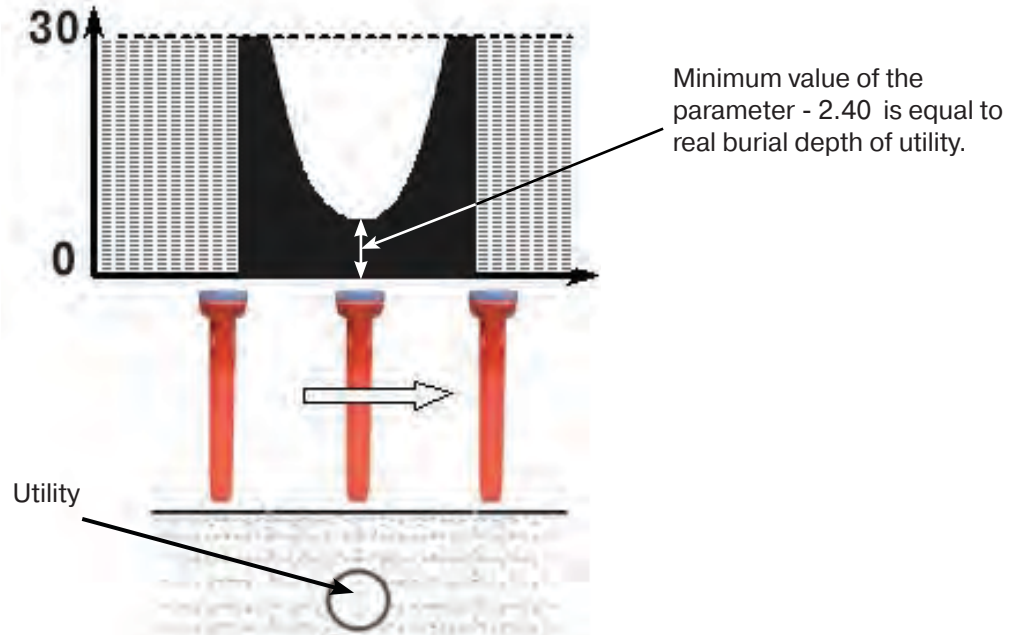

The receiver has two modes with indication of “relative distance to the utility”: “**R.dis. Graph**” is used when the “relative distance to the utility” graph and utility route are indicated simultaneously, whilst the “**MIN&R.Dist mode**” is used when screen of the receiver indicates 2 graphs (minimal signal and “relative distance to the utility”).

### 2.5.1 “R.dis. Graph” mode

This mode is the same as “Graph” mode. The screen is split in two parts, an upper display and a lower display.

- Upper Part: Route axis indication
- Lower Part: “relative distance to the utility” graph

#### Indication of “R.dis. Graph”:

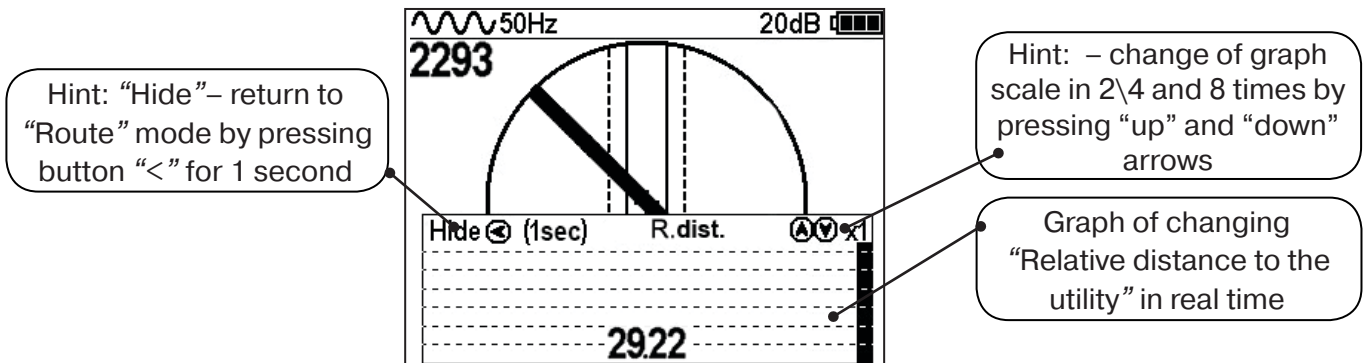



When two utilities are buried close to each other while moving the receiver straight across the utility axis in “R dist” mode, an operator will be able to see the indication shown below:

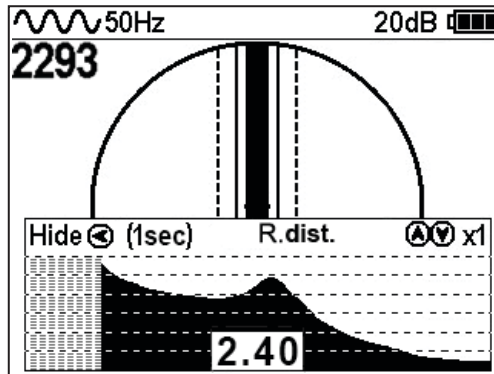

Minimal values of “relative distance to the utility” indicate the presence of the utility with some fault because in the case of multiple utilities laying nearby, minimum signal point may move due to confluence of the signals.

You can enable the “**R.dis.Graph**” mode from “Route” mode by pressing the “>” button or by switching it in the “Modes” section of the receiver’s main menu.

### 2.5.2 “MIN & R.Dist” Mode

In this mode the screen is split in two parts. Upper part: Minimal signal graph, lower part: “relative distance to the utility” graph in real time.

Digit indicates the minimum signal level of far right point of the display

Hint – change of graph scale in 2, 4 and 8 times by pressing “up” and “down” arrows

Digit indicates relative distance value of far right part of the display

“R.dist” value indicated by “∞” icon

You can enable “MIN & R.Dist” mode only from “Modes” section of main menu.

### 2.6 “2 Frequencies” Mode Window

In the “2 frequencies” mode, the cable condition and pipeline protection diagnostic is performed using the external generator. When conducting works on cable route location, it is possible to select the communication located as “my own” and perform a route location on it.

Quick reset of readings and “reference” to the utility

Frequency components change of phase difference

Amplification coefficient in dB

Battery charge level

Signal direction (straight / reverse)

Frequency components amplitude modulation (A8/A1)

The sum of frequency components (A8+A1)

Signal level on 1024 and 8192 Hz

**IMPORTANT NOTE:**

**Modes are split in two sets: basic and extended. In basic set, only 3 modes are available: "Route", "Graph" and "R.dis.graph". All modes are available in extended set: "Route", "Graph", "Graph+", "MIN & MAX", "2 Frequency", "R.dis.graph" and "MIN&R.dist.". You can switch between two sets in menu: Settings -> Modes select.**

**Dynamic Overload Protection**

There is protection in the receiver which prevents the influence of dynamic overload. When the receiver is operated in the area with tense electromagnetic fields, this function automatically reduces the incoming signal and prevents the electronics of the receiver from being damaged and notifies the user with a special message on the screen.

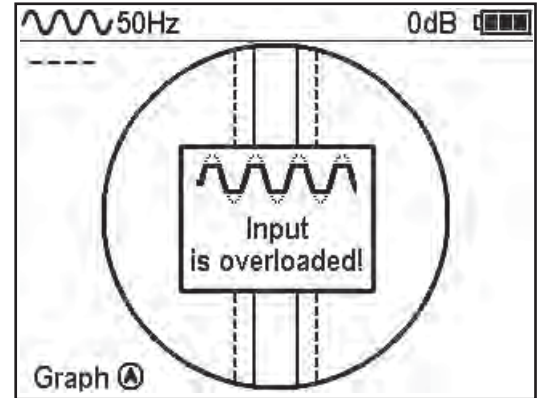

### 3. Receiver menu description

#### 3.1 Receiver switching on and menu call

<p>To switch on the receiver press the button «Power»</p> 		<p>Press «Enter» button to open the Menu</p> 	
---	---	--	---

#### 3.2 The general view of the menu screen



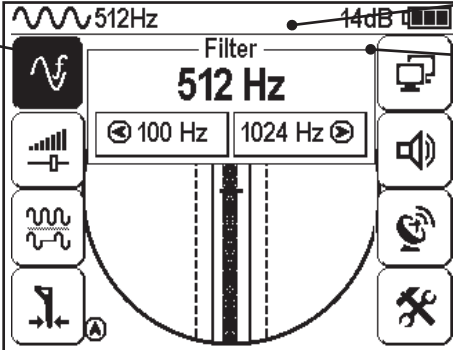



The selected menu option is highlighted with the dotted line, flashes with light/dark

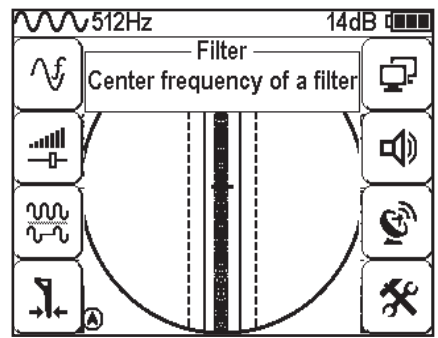

menu option name

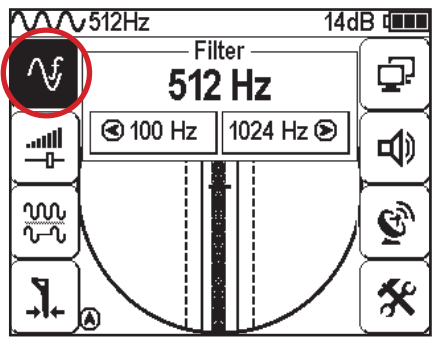
brief menu option description

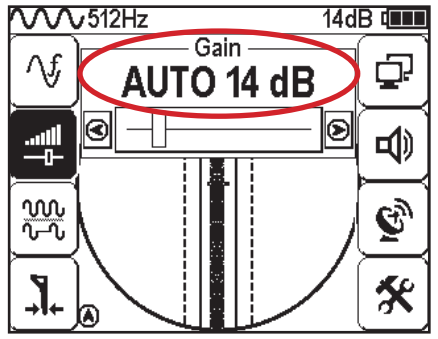





#### 3.3 Menu parameter selection



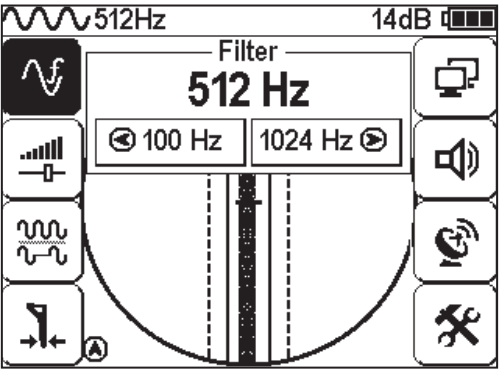

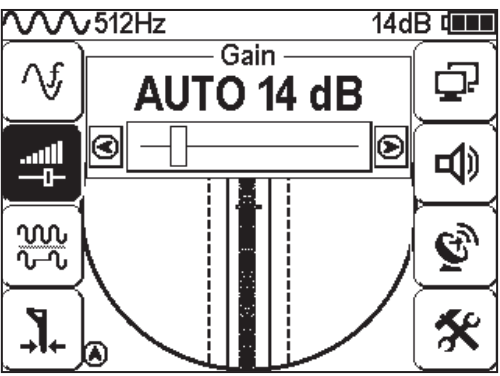
 <p>To open the menu press «Enter».</p>	 <p>The menu will appear on the screen.</p>	 <p>Menu option selection is performed with buttons «Up», «Down», «Right», «Left».</p>	 <p>Active "icon" is flashing and highlighted by dotted line</p>
 <p>to change or view the menu item</p>	 <p>In the upper part of the indicator the parameter editing panel will open.</p>	 <p>The changed value is immediately applied.</p>	 <p>To exit the menu to the general menu or transfer to the set mode with the closing of the menu, you should press the button «Enter». If you wait for several seconds, menu icons will disappear.</p>

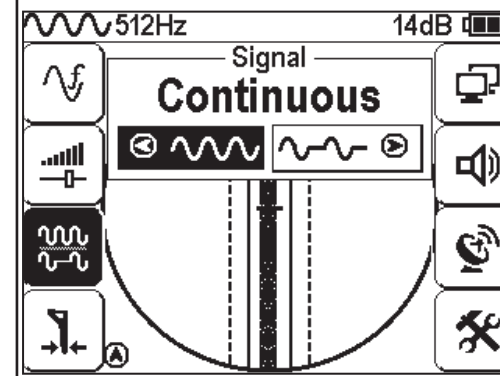

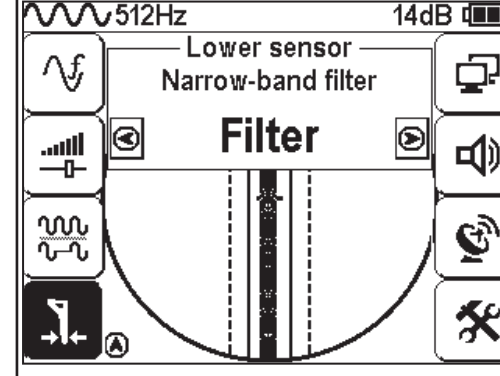

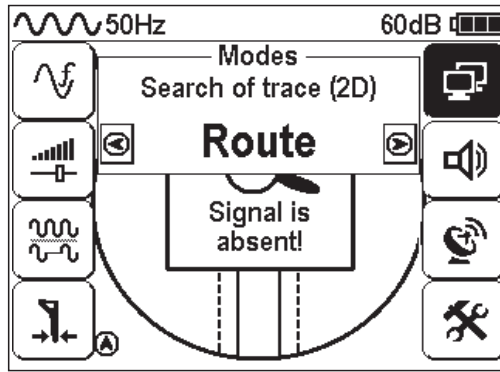

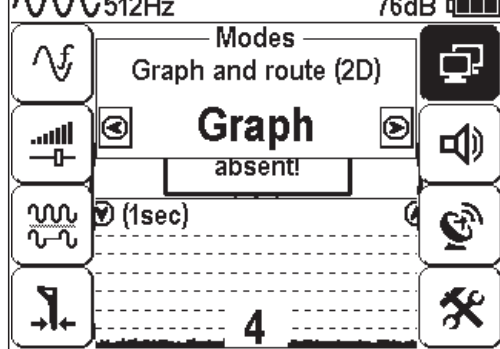
**If you don't press any buttons for a period of time, the menu will disappear automatically. The length of this period is set in the corresponding menu option (see Table 1. p.6)**

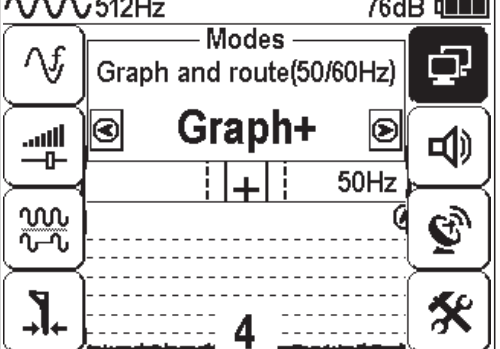
Thirteen items of menu contain parameters of setting, which are opened in the panel located in the upper part of the indicator.

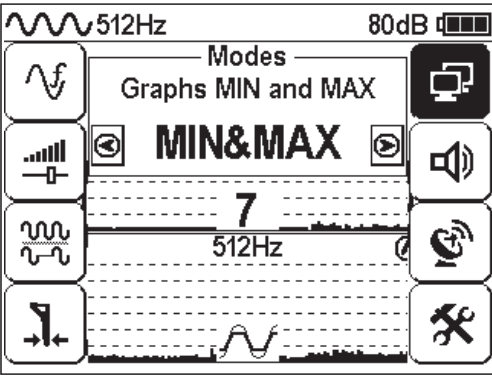
**Table 1**

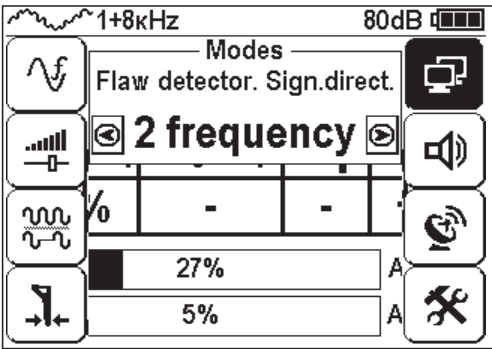
№	Item of the menu	Display image	Parameter description
1	Filter 		The working frequency of the receiver It is selected from the set: <b>50(60) Hz, 100(120) Hz, 512 Hz, 1024 Hz, 8192 Hz, 32768 Hz.</b>
2	Gain 		The amplification coefficient of the scaling amplifier can be changed from <b>0 dB to 80 dB</b> with 2 dB step. The optimum coefficient of amplification can be selected: - <b>manually,</b> - <b>semiautomatically</b> (by a command), - <b>automatically</b> depending on the regime of the analysis and signal representation.
3	Signal 		The type of signal received can be « <b>Continuous</b> » or « <b>Impulse</b> ».
4	Advanced bottom sensor setting 		This option has several settings affecting the efficiency of bottom sensor. - « <b>Filter</b> » (narrow-band filter) - « <b>WB</b> » (wide band, sensor receives all frequencies below 8kHz). - « <b>Radio</b> » (sensor receives all frequencies over 8kHz). ‘Filter’ setting is used only in ‘Route mode’, other settings are used in ‘Graphic’ mode.

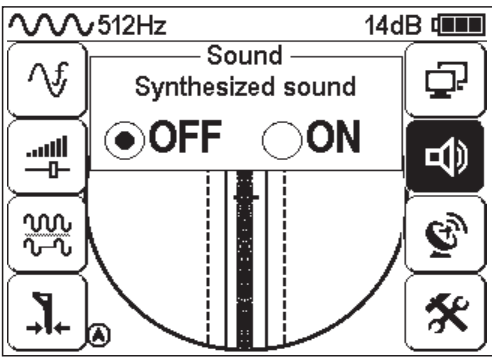
5	<p>Base Mode</p> 		<p><b>Set of modes:</b></p> <p>- «<b>Route</b>» (2D display of the location of the route cable;</p>
6	<p>Base Mode</p> 		<p>- «<b>Graph</b>» (visually represents the changes of signal level of surveyed cable);</p>
7	<p>Advanced Mode</p> 		<p><b>Advanced mode:</b></p> <p>- «<b>Graph+</b>» (this mode combines two previous modes and allows to locate two cables simultaneously: one on 50Hz, and the other on frequency set by transmitter.z);</p>

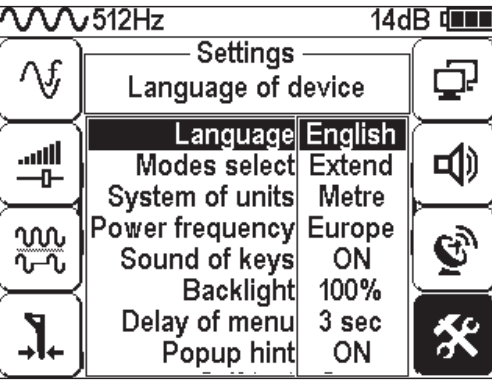
8	<p>Advanced Modes</p> 		<p><b>Advanced mode:</b></p> <p>- «MIN&amp;MAX» (graph representation of minimum and maximum signals)</p>										
9	<p>Advanced Modes</p> 		<p><b>Advanced mode:</b></p> <p>«2 frequency» (simultaneous operation in two frequencies, also know as frend-or-foe mode).</p>										
10	<p>Sound</p> 		<p>Switching on / switching off of sound notifications the created by the built-in speaker.</p>										
11	<p>Settings</p> 		<p>This menu is opened in the main field of an indicator</p> <table border="1" data-bbox="853 1444 1492 1758"> <tr> <td><b>Language</b></td> <td>&lt;Russian/English&gt;</td> </tr> <tr> <td colspan="2">Locale of the device</td> </tr> <tr> <td><b>System of units</b></td> <td>&lt;Meter/Foot&gt;</td> </tr> <tr> <td colspan="2">Measurement system: metrical or imperial</td> </tr> <tr> <td><b>Network frequency</b></td> <td>&lt;Europe/USA&gt;</td> </tr> </table> <p>The network frequency for passive search: «Europe» (50 и 100 Hz) / «USA» (60 and 120 Hz).</p>	<b>Language</b>	<Russian/English>	Locale of the device		<b>System of units</b>	<Meter/Foot>	Measurement system: metrical or imperial		<b>Network frequency</b>	<Europe/USA>
<b>Language</b>	<Russian/English>												
Locale of the device													
<b>System of units</b>	<Meter/Foot>												
Measurement system: metrical or imperial													
<b>Network frequency</b>	<Europe/USA>												

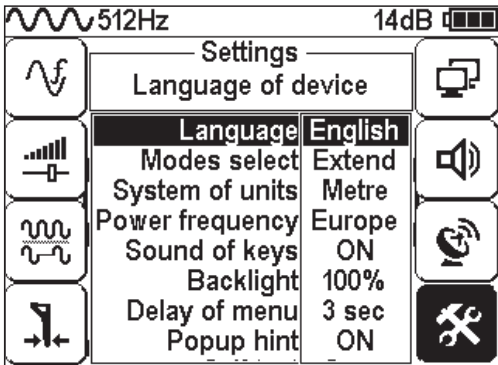
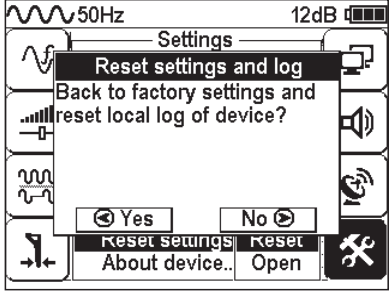
12	Settings 		<b>Sound of keys</b> <ON/OFF>
		Disables keys sound	
			<b>Delay of menu</b> <1 sec/2 sec/ 3 sec/ 4 sec/5 sec>
			Time-out before closing the menu when no buttons are pressed.
			<b>• Popup hints</b> <ON/OFF>
			Disables pop-ups with useful hints.
			<b>• Reset osettings</b> <Reset>
			Resets the receiver to factory settings 

## 4. Start of work

**If alkaline batteries are used** - Before start of work, you should install the batteries into the corresponding compartment of the receiver in the following sequence:



Unsnap Battery compartment. Pull out the ring on the receiver handle.



Install the batteries, observing the polarity



Install four new elements into the battery compartment of the device, minding polarity. Install the battery compartment into the body until it snaps.

## Receiver switching

To switch on the receiver, press the “Power” button 

The indication of the Firmware version, manufacturer logo and device name will appear on the screen.

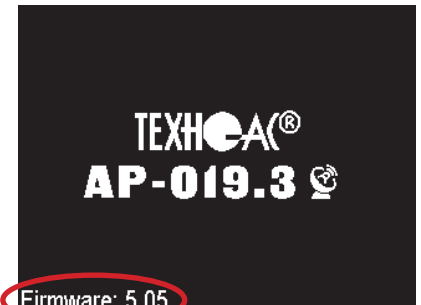

Then, the receiver will automatically enter into “Route” mode in 5 seconds. When first switching, the factory settings are set by default . The filter frequency is 50 Hz.

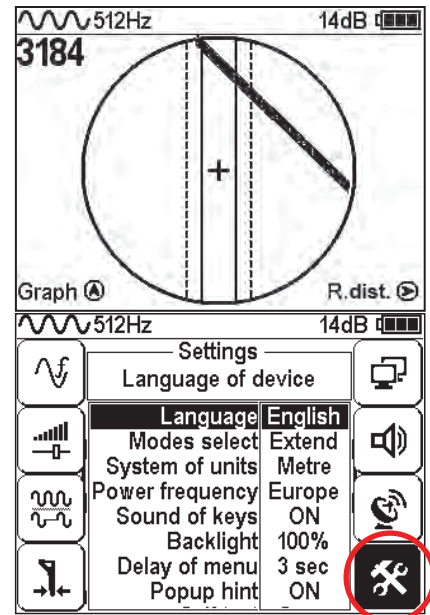

**Note**

A description of factory settings can be found in the “settings” menu. You can go back to factory settings by selecting the “reset settings” option.

**With factory settings enabled, you can perform the cable location with network frequency 50 Hz without the transmitter.**

## External Power

With the help of the mini-USB cable (included), the operator can connect to external power sources with 4-7V voltage. For example, a power bank (supplied separately).

The external power source can be placed under overclothes of the operator. It will allow an extension of the battery life in low temperature conditions. External power can be used with inserted batteries or without them.

**NOTE:** Power Bank should be placed as far as possible from the antenna block of the receiver in order to evade interference.



### Basic Receiver Functions

- Location and tracing of underground utilities with depth measurement in “Route” mode.
- Location and tracing of utilities in “Graph”, “Graph+”, and “MIN & MAX” modes.
- Tracing of non-metal utilities in “Sonde” mode.
- Saving of coordinates and parameters of located points.
- Operation in “2 Frequency” mode (fault location and detection of signal direction).
- Selection of the cable from a bunch with inductive clamp.

### 5. Search of Utilities in “Route” mode









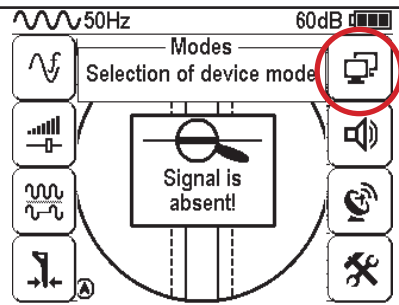

Route mode is the main mode for route location of various utilities (cables & pipelines) at all supported frequencies, both in “passive” cable route location and at the “active” (with the use of the route locating generator). In passive mode, the cable location is carried out at frequencies of 50(60) and 100Hz, while cable location in active mode is performed at frequencies of -512, 1024, 8192 and 33Hz.

#### 5.1 Cable Location in Passive Mode

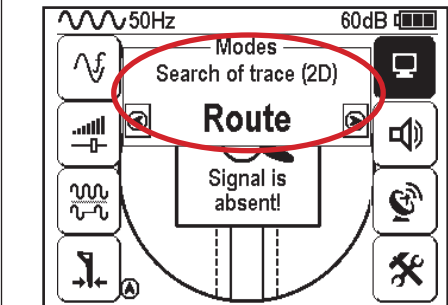
This mode is used to search and locate the route of power cables under voltage with a frequency of 50(60) Hz and other communications with the induced signal in frequency 50(60) Hz. The external generator is not used.

#### Receiver Setting for Operation in “Route” Mode

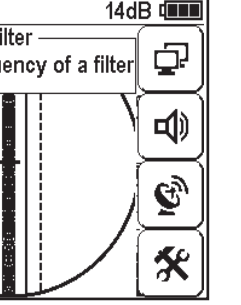
To enable “Route” mode, please, do the following:

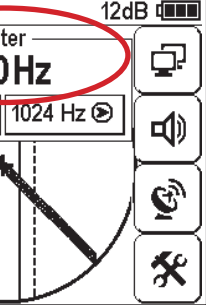
<p>Turn on the receiver</p> 	<p>Press “enter” button in order to open main menu</p> 		<p>Press “enter” to enter the mode change menu</p> 		<p>Choose “Route” buttons</p> 
<p>Press “enter” button in order to open main menu</p> 	<p>Then go to “Filter” menu</p> 		<p>Press “enter” to enter the mode change menu</p> 	<p>Select 50(60) Hz frequency</p> 	

When filter 50(60)Hz is chosen, the type of incoming signal is automatically set to continuous.

## 5.2 Search of a Communication and Measurement of its Burial Depth

1. Come to the supposed place of the utility under the voltage or induced voltage in frequency 50(60)Hz.

2. If the utility is far from the operator, you will see on the screen:

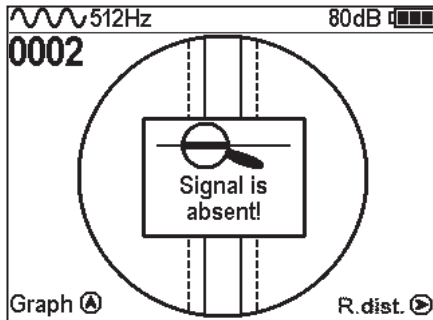

3. When moving towards the supposed place of the utility location, the “ball” will appear on the screen. It shows the presence of a utility and that it is a significant distance from the operator.

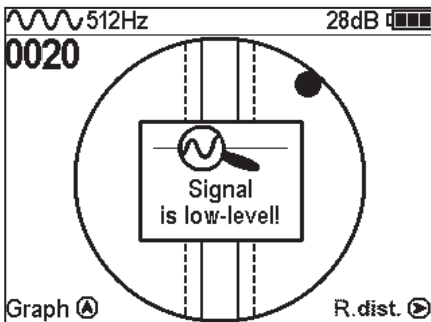

4. The “ball” position shows the direction of the utility relative to the operator.

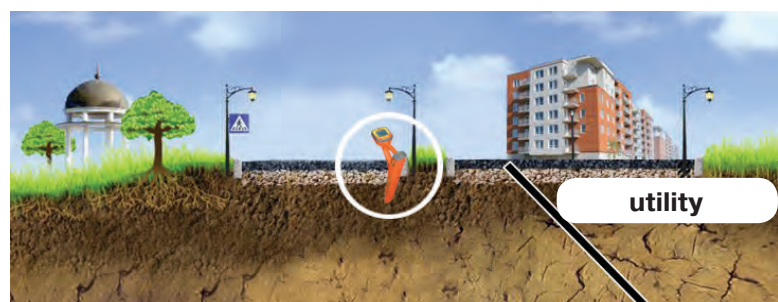
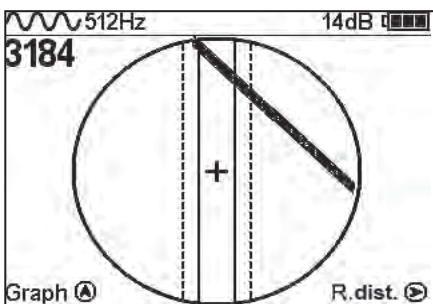

5. When the operator moves closer to the utility, the axis will move to the centre of the circle. This means that the operator is standing directly over the utility

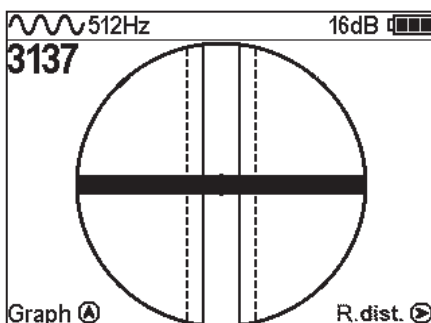

## The measurement of the burial depth of utility

7. Further you should rotate the device, until the utility axis is aligned along the receiver axis. In this position, given 'f' (the current in the cable) is sufficient, the window will appear displaying its burial depth and current. Now, the operator stands alongside the utility.

In this position, it is possible to move forward and trace a whole cable).

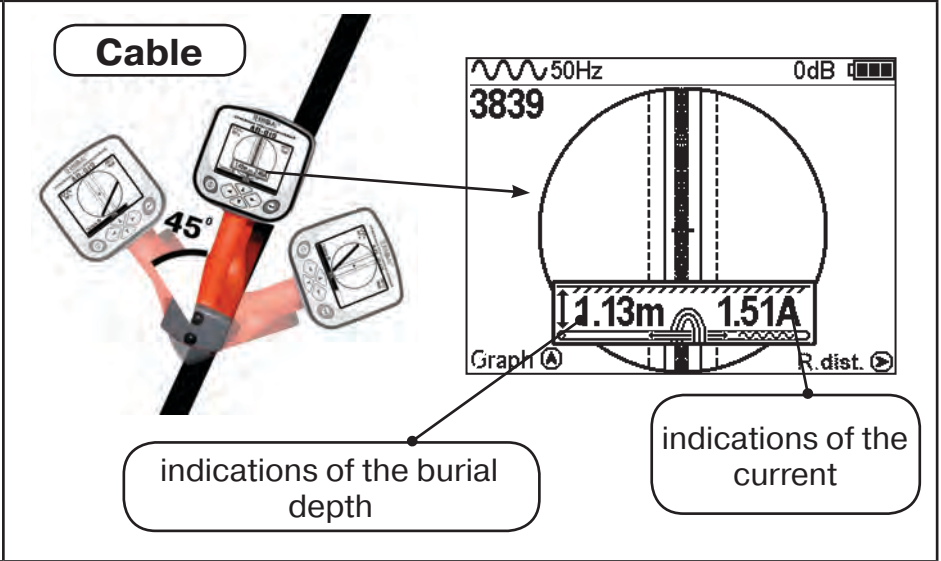

**Note**

Power cables most frequently lay at a depth of 60-80 cm, allowing to differ them from pipelines. It is possible that a cable lays in one channel with a pipeline, when the burial depth can significantly exceed 1 metre.

If the communication axis cannot be located exactly in the limited area, and the periodical jumps are happening from one border to the other, it indicates the presence of several cables under voltage with the 50 Hz frequency. You can specify number and position of the cables in "Graphic" mode.

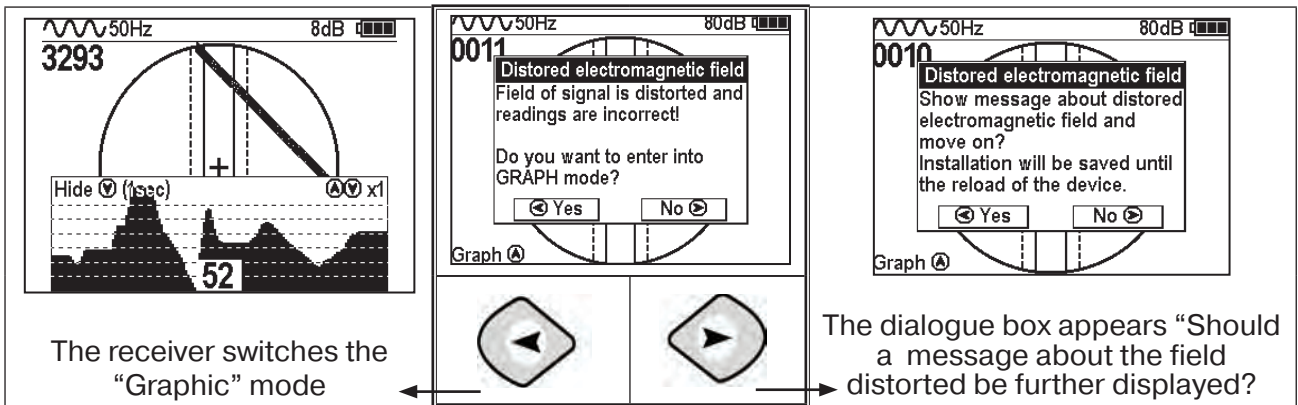

**In a case when the signal is significantly distorted, the receiver automatically shows the corresponding notification, offering the option of switching to "Graph" mode.**

**Attention:**

Before measuring the depth of the utility, make sure that your device is positioned perpendicularly to the utility. Even a slight deviation from vertical position can influence the precision of the depth measurement.

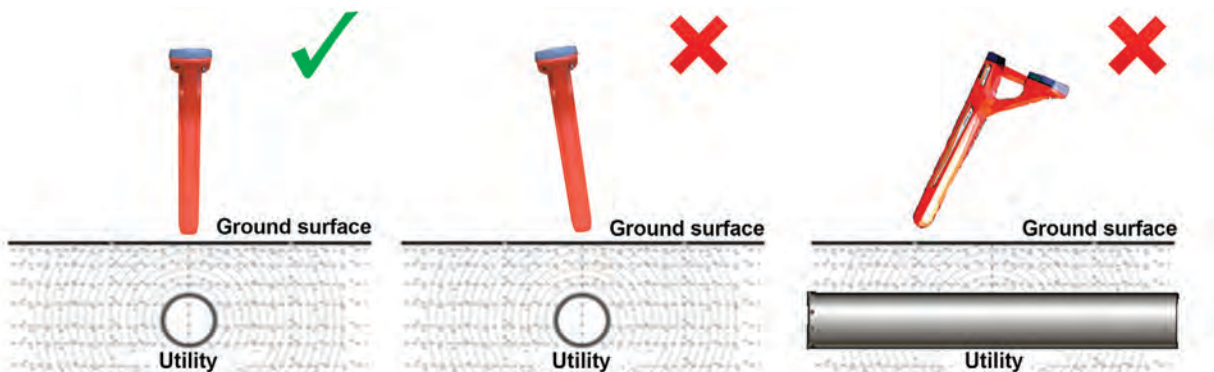

### 5.3 Cable Route Location in the Active Mode

This mode is used for the location and tracing of electro-conducting underground utilities (power cables, optic fibre cables with metal armouring and pipelines) by using the signal transmitter. Tracing is possible at the following frequencies: **512, 1024, 8192 and 32768 Hz.**

The filter on the receiver is set manually in accordance with the selected generator frequency.

When locating the cable route in the conditions of the large number of surrounding utilities, you should set the frequency **to 512 Hz.**

When it is impossible to ground the connection, you should select higher frequencies. To perform the cable location with damage detection, you should select a higher frequency.

**Note**

#### Transmitter Connection

**Contact mode**  
The generator output is connected directly to the communication

**Contactless method**  
using the transmitting antenna

**Note**

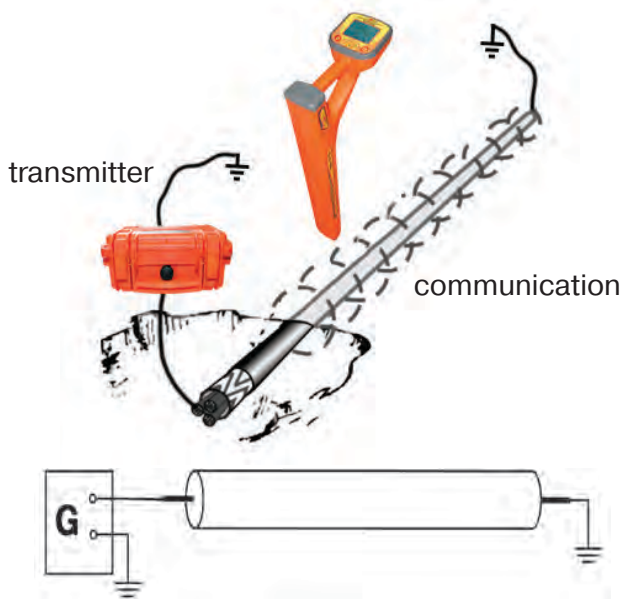

**Contactless method**  
Connection with internal inductive antenna of the transmitter

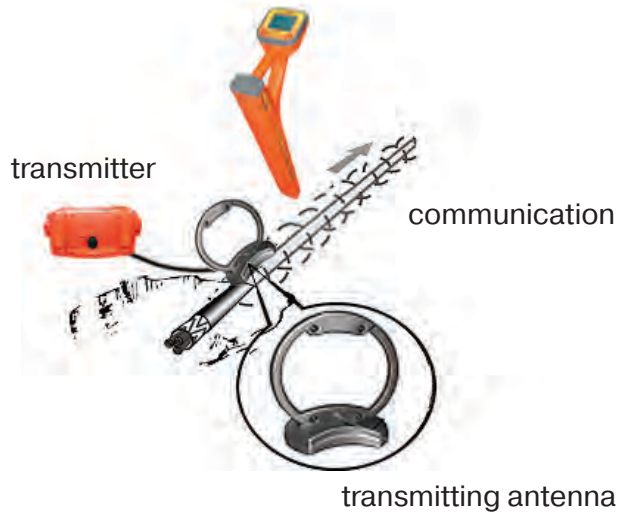
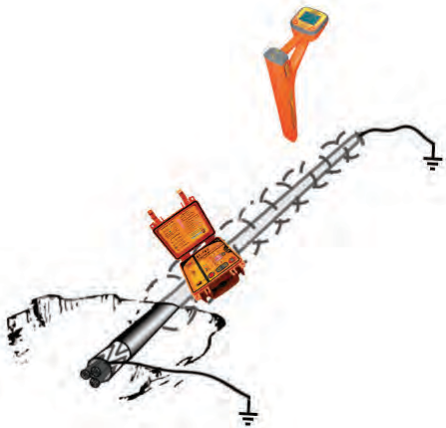



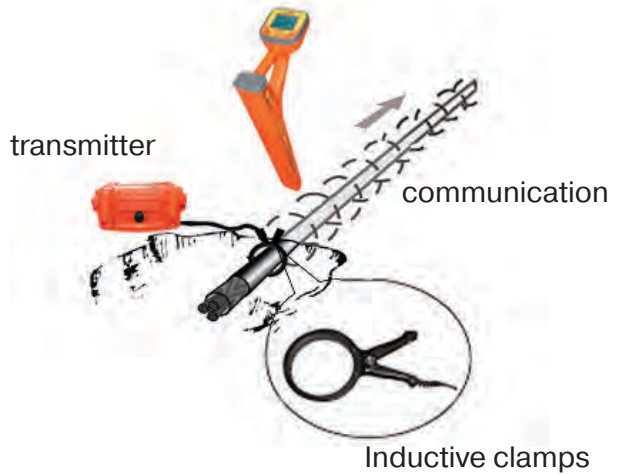







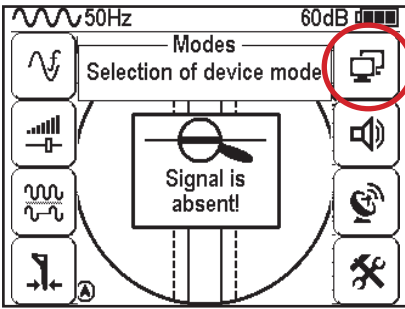

**Contactless method**  
using the induction clamps

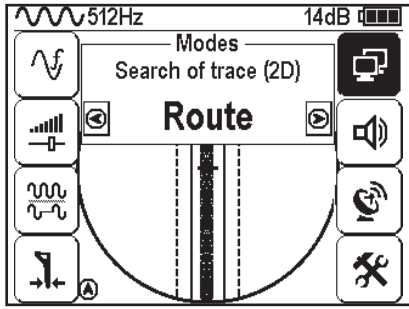



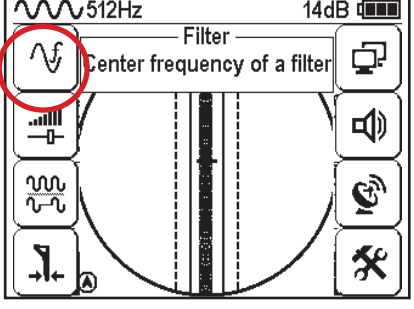

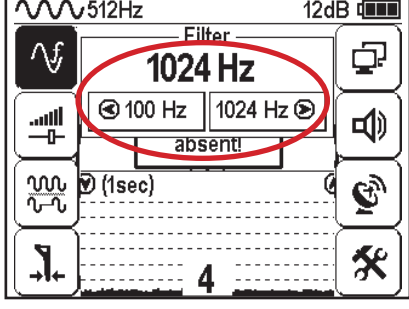
### Procedure for search of communication and conduction of cable route location

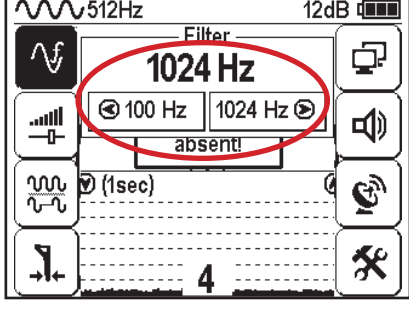

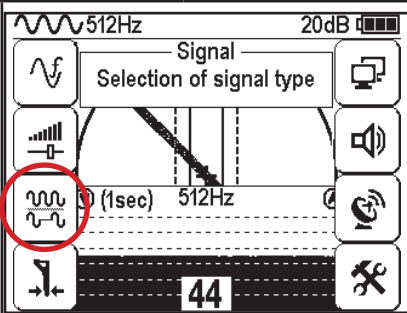
<p>1. Connect the transmitter to the utility by contact or contactless method.</p> <p><b>Note</b> When possible, the preference should be given to the contact method of connection, which allows the user to perform the cable route location for more distantly.</p>	<p>2. Turn on the transmitter. Set the signal type - impulse "Co"/continuous "Pu" / pulse. The generation frequency on the transmitter - 512, 1024, 8192, 32768 Hz.</p> <p><b>Impulse mode (Pu)</b> is used to increase the time of work of the transmitter.</p> <p><b>Continuous signal (Co)</b> makes it possible to conduct simultaneously with the routing and the diagnostic of the faults of the power cable.</p>
<p>3. Start the generation, wait for the transmitter to power up.</p>	<p>4. Proceed with the setting of the receiver</p>

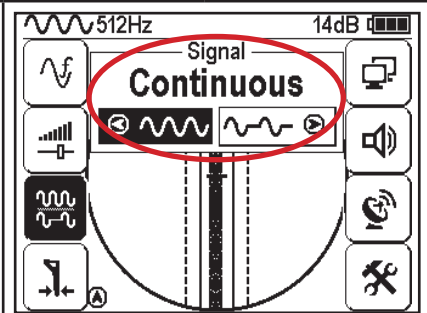
### Setting of the receiver for the active search. "Route" mode

<p>Turn on the power</p> 	<p>Press "Enter" button to open the menu</p> 	 <p>Select the icon "Modes" in the menu</p> <p>buttons</p> 	<p>To confirm your selection press "Enter" button.</p> 	 <p>Select the "Route" mode</p> <p>buttons</p> 
<p>Press "Enter" again to return to main menu.</p> 	<p>Select "Filter" in the menu.</p> 	 <p>To confirm your selection press "Enter" button.</p> 	<p>Set the filter frequency corresponding to the transmitter frequency, for example 1024 Hz</p>  <p>buttons</p> 	

 <p>Press "Enter" again to return to main menu</p>	 <p>Select "Signal" in the menu</p> <p>buttons</p> 	 <p>To confirm your selection press "Enter" button</p>	 <p>Select the type of signal</p> <p>buttons</p> 	 <p>Press "Enter" again to return to main menu</p>
---	---	---	--	---

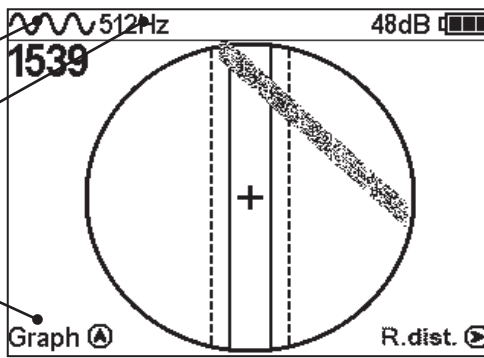
### View of the Receiver Screen for Route Location in the Active Mode

<p>The input signal type set in the receiver (continuous)</p>	
<p>The set filter frequency - 512 Hz</p>	
<p>A hint for switching to the "Graphic" mode by the short pressing of the button </p>	

Having set up the receiver, you can start locating communication and determine its burial depth **similarly to p. 5.2.**



When working in the "Route" mode, the following can sometimes occur:











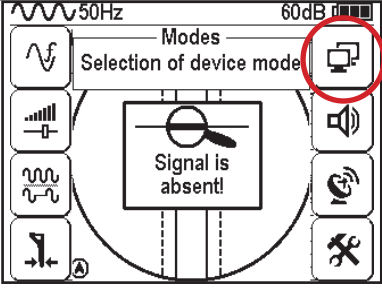

- the positioning of the utility axis into the centre is impossible
- the presence of several near located communications
- low signal in the cable

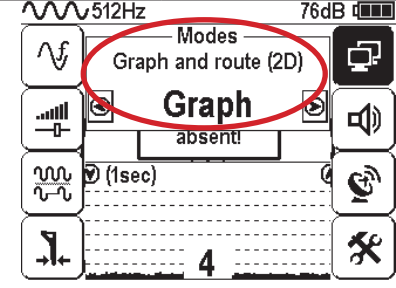
In these cases, you should switch to the "Graph" mode.

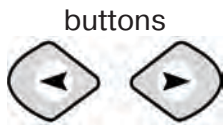
## 6. Search of Utilities in “Graph” Mode

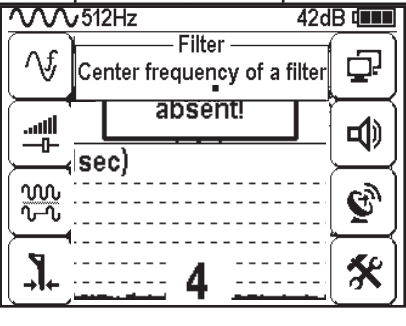

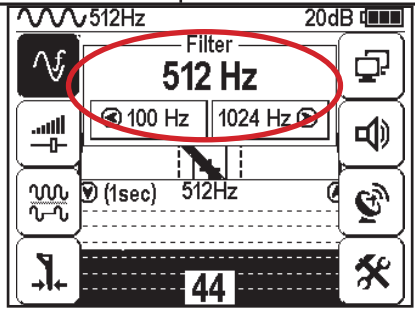



The “Graph” mode is the support mode and is able to locate various utilities (cables and pipelines), both in the passive and active modes with the route locating transmitter. In passive mode, the cable location is carried out at frequencies of **50(60) and 100(120)Hz** and in the active mode - **512, 1024, 8192 and 32768 Hz**. The “**Graph**” mode can be used to determine the number of the near located utilities. The “**Graph**” mode also allows the user to perform the route location in conditions of low signal on the utility, when the route location in the “**Route**” mode is impossible. The measurement of the burial depth and current is not available in this mode. In the “**Graph**” mode, the receiver screen displays the moving diagram of change in the signal level, depending on the time by the “maximum” method - when located over the utility, the signal is maximum, and when deviating from the axis, the signal decreases.

### 6.1 Setting of the Receiver for Work in the “Graph” Mode

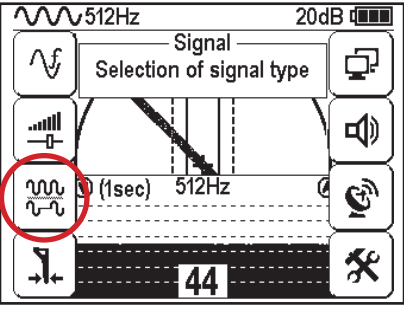
<p>Turn on the power</p> 	<p>Press “Enter” button to open the menu</p> 		<p>To confirm your selection press “Enter” button</p> 	
<p>Select “Modes” in the menu</p>		<p>buttons</p> 	<p>Select the mode “Graph”</p> 	
<p>Press “Enter” again to return to main menu</p> 		<p>To confirm your selection press “Enter” button</p> 		
<p>Select the “Filter” in the menu</p>		<p>buttons</p> 	<p>Set the filter frequency in accordance with the generator frequency, for example, 1024Hz</p> 	

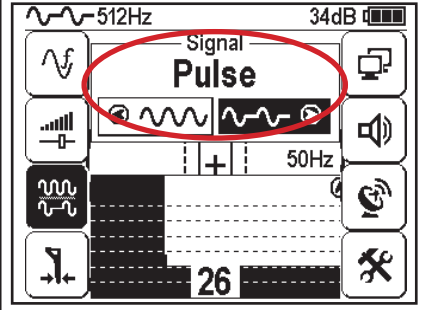





\* At the active search, the signal should be transmitted on the route from the generator with the same frequency as on the receiver (p. 5.5).

In the **“Graph”** mode the work is performed in the **“Continuous”** or **“Impulse”** signal. The difference at the work with the **“Impulse”** signal is in that the digit in the center of the analogue scale shows not the current value of the signal, but the maximum value (amplitude) of the transmissions of the interruptible signal from the route locating transmitter. The pitch of the tone of the sound synthesized also corresponds to the maximum value of the signal for the period of the impulse transmitted.

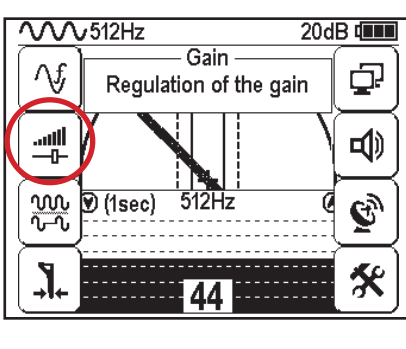
 <p>Press “Enter” again to return to main menu.</p>		 <p>To confirm your selection press “Enter” button.</p>		 <p>Press “Enter” again to return to main menu.</p>
	<p>Select “Signal” in the menu.</p>	<p>buttons</p> 	<p>Select the signal type, for example, impulse, and in accordance with the generator signal</p>	<p>buttons</p> 

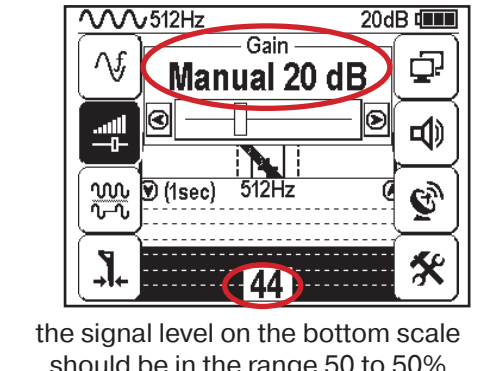
**Note** When working in the passive mode **50(60) Hz, 100(120) Hz** - you should always select the **continuous type of the signal**.  
When working with the generator (in the **active mode**) **512, 1024, 8192 Hz, 33 kHz** - the type of the signal on the receiver is **continuous or impulse**, in accordance with the signal set on the transmitter.





During the route location, you can manually set the input signal amplification.

 <p>Press “Enter” button to open the menu</p>		 <p>To confirm your selection press “Enter” button..</p>		 <p>Press “Enter” again to return to main menu.</p>
	<p>Select “Amplification” in the menu.</p>	<p>buttons</p> 	<p>the signal level on the bottom scale should be in the range 50 to 50%</p> <p>Set the amplification coefficient, for example, 20 dB</p>	<p>buttons</p> 



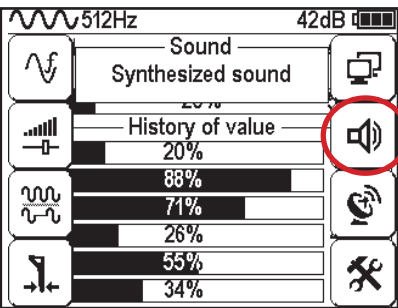

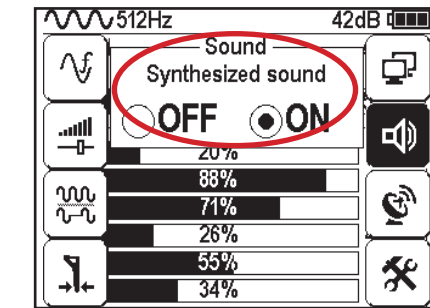
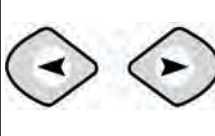
The change of the input signal amplification coefficient should be performed manually by short pressing buttons   or semi-automatically by holding one of them pressed for 1 sec.

In the “Graphic” mode it is possible to listen synthesized sound through the built-in speaker, The sound tone pitch changes depending on the signal level.



 <p>Press “Enter” button to open the menu</p>	 <p>Select “Sound” in the menu</p> 	 <p>To confirm your selection press “Enter” button.</p>	 <p>Select necessary parameter</p> 	 <p>Press “Enter” again to return to main menu</p>
--	---	--	--	---

## 6.2. “Hot” Keys for Work in the “Graph” Mode

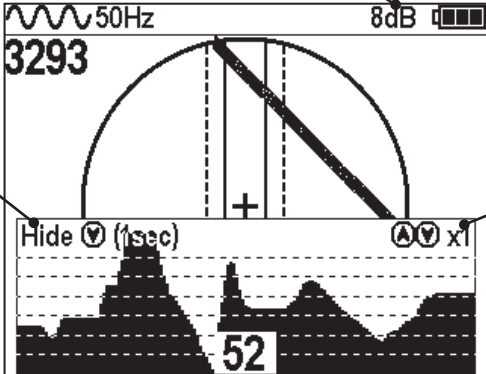

decrease / increase (2 dB at time) the amplification, shortly press  

Turning off the Graphic mode  and switching to the Route mode by long pressing button



increase/decrease of the image x1, x2, x4, x8 by the short pressing of the buttons  and  correspondingly

**Note** If the signal occupies the whole graphic (the black string), it is necessary to perform the following actions:

1. Decrease the graphic scale to the value x1 by pressing button 
2. Decrease the signal amplification coefficient by pressing button  until the appearance of the decrease of the input signal level is less than 80%.
3. In case of low signal, increase the amplification coefficient by pressing the button and the scale by pressing this button 

### 6.3. Search of Utilities in “Graph” Mode

1. Perform the receiver setting - select the Graphic mode
2. Locate the receiver in parallel to the supposed axis of the utility, slowly move in the direction, as shown in the figure below.
3. Slowly move the receiver towards the area where you previously experienced problems locating the utility.

You can see the example of operation on this picture:



In the presence of two utilities, the approximate view of the graphic on the receiver screen is shown in the figure.

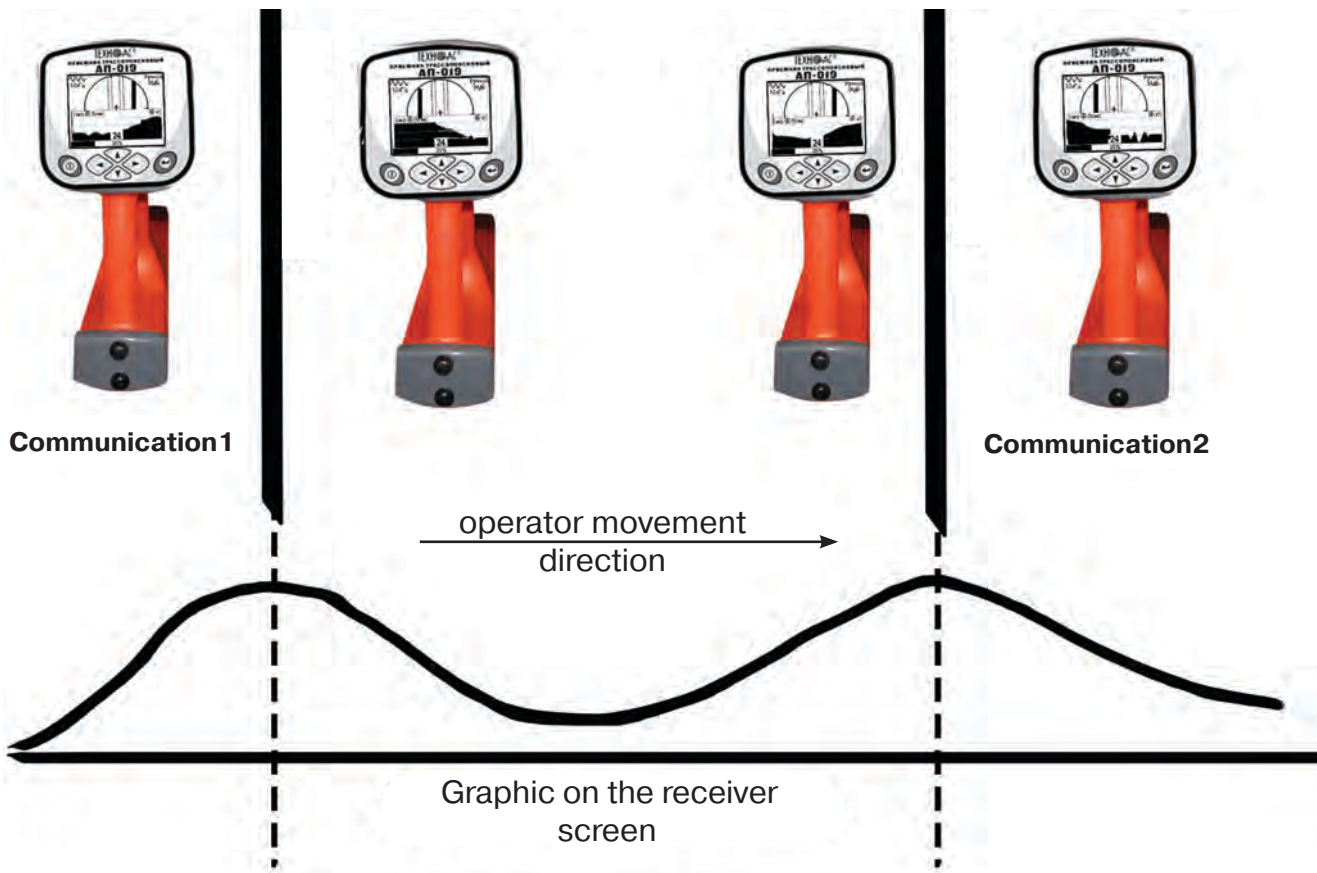

4. You should locate the utility by the maximum signal level.

## 7. Search of Utilities in “Graph+” Mode

The “Graph+” mode is available in the advanced set of modes. “Graph+” is the auxiliary mode. This mode differs from the mode “Graph”, as it shows a “2D” image compatible with the graphic, not the relative position of the route, but automatically demonstrates the presence and provision of the near “power” cable under the voltage with the frequency 50(60) Hz.

### 7.1 Setting of the Receiver for Work in the “Graph+” Mode

The setting of the receiver and use of the “hot keys” for work in the mode “Graph+” fully matches with the setting of the receiver for the “Graph” mode (see sections 7.1 and 7.2).

### 7.2 Search of Utilities in the “Graph+” Mode

<p><b>Note</b></p> <p>1. 1. Connect the transmitter to the communication by contact or contactless method.</p> <p>When possible, preference should be given to the contact method of connection, which allows the user to conduct the cable route location more distantly.</p>	<p><b>Note</b></p> <p>2. Turn on the transmitter . Set the signal type - impulse “Pu”/continuous “Co”. The generation frequency on the generator: - 512, 1024, 8192, 32768 Hz. Impulse mode is used to increase the working time of the generator. Continuous signal provides the option to perform simultaneously with the routing the diagnostic of the faults of the power cable.</p>
<p>3. Set up the receiver for work in the “<b>Graph+</b>” mode (section 7 1), set the frequency and type of the signal the same as on the transmitter</p>	<p>4. Start the generation, wait for the transmitter to power up.</p>

### View of the Receiver Screen for Route Location in the Active Mode

The input signal type set in the receiver (continuous)

The frequency of the filter set (1 kHz) for the graphic

The graph of the change of the input filtered signal (1 kHz)

The place of cable location with the transmitting frequency 50(60) Hz

50(60) Hz means it is in “Graph+” mode

Hint of the increase/decrease of the image x1, x2, x4,x8 by the short pressing of the buttons and correspondingly

5. Approach the supposed place of cable route, on which the signal from the generator was transmitted. Locate the receiver axis in parallel to the utility axis.

The graph showing the change in the signal level will be displayed on the screen in frequency 1 kHz, on the 2D image of the route of the cable located near (if any) will be displayed under the voltage 50(60)Hz.

You should move the receiver as shown on the figure.

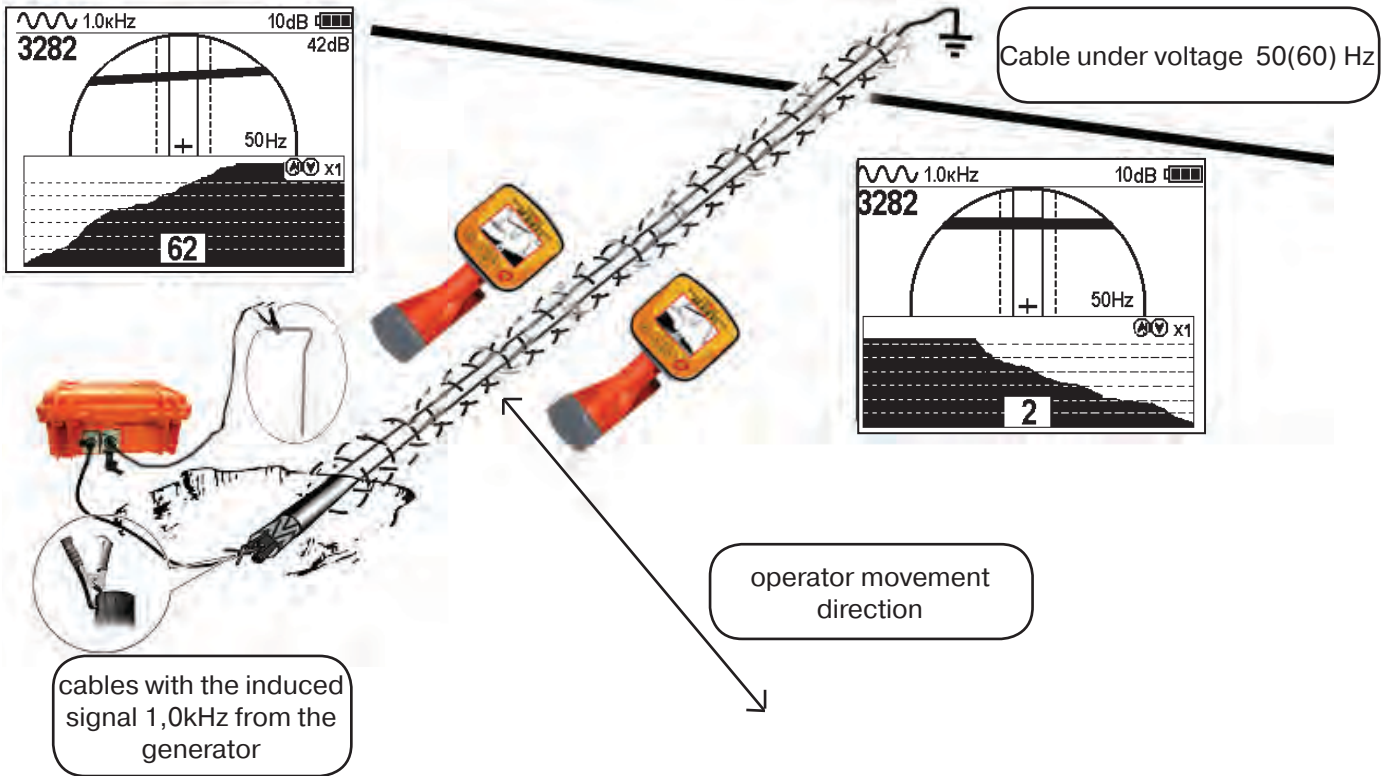

The place of the crossing of the cable corresponds to the setting of the pointer “50 Hz” onto the centre of the circle at maximum value of the indication on the “Graph” of the active frequency signal.

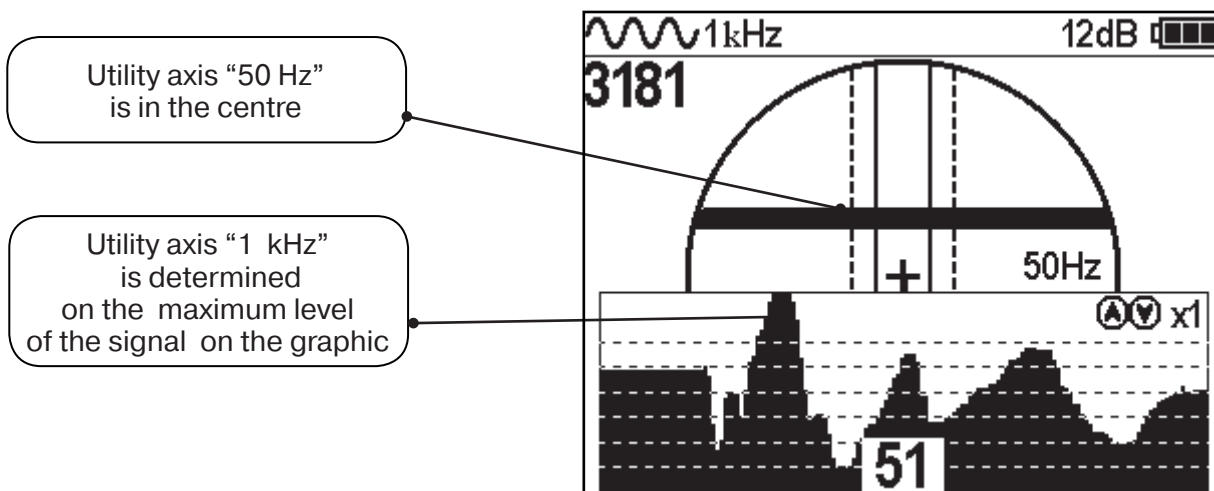

## 8. Performing a Cable Location in the Mode “MIN & MAX”

In the mode “MIN & MAX”, the device works simultaneously both on the method “maximum” and the method “minimum”. This mode is used in the conditions of distorted field, in the presence of nearby utilities and at the low induced signal. It allows the user to perform location and to determine the presence and location of utilities located nearby.

In the “MIN & MAX” mode, the receiver display is divided in two halves. The moving diagram of the signal level change is displayed in the upper part by the “minimum” method - when located over the cable, the signal is minimal, and when deviating from the axis, the signal increases. The bottom half of the screen shows the moving diagram of the signal level change depending on the time by the “maximum” method - when you stand over the cable, the signal is maximum, and when deviating from the axis, the signal decreases.

In this mode, the value of the depth and current in the utility are not displayed.

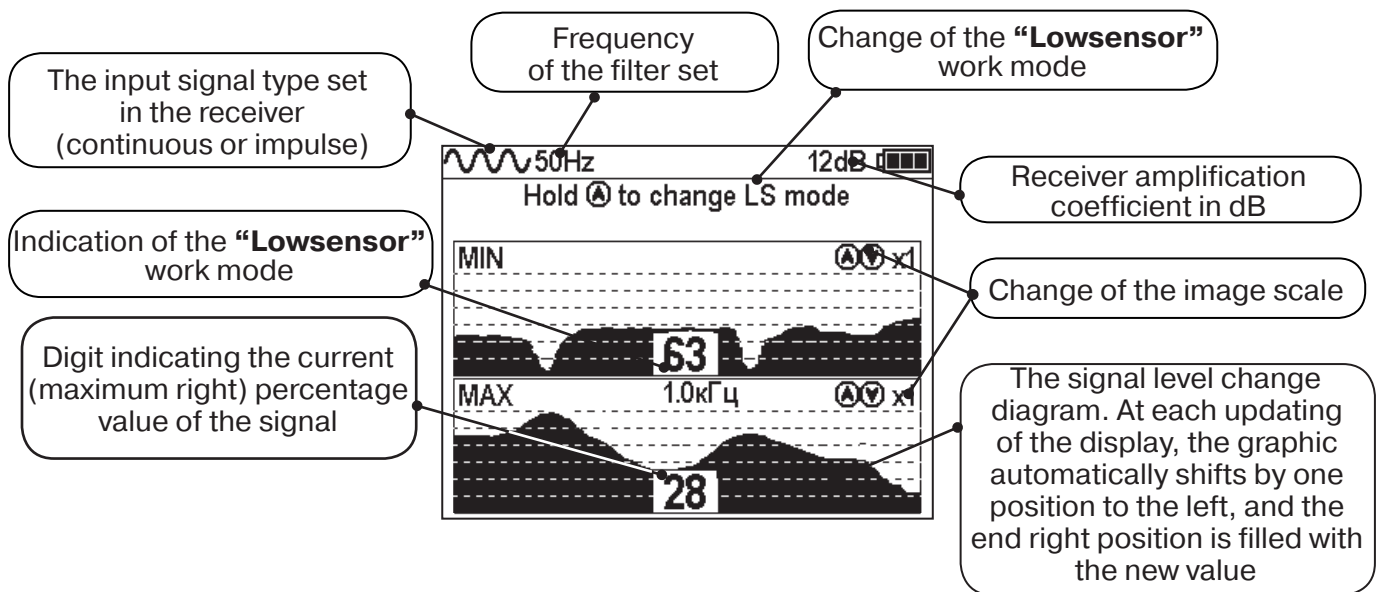

The cable route location is performed similarly to route location in the “Graph” mode, orienting on the maximum level of the signal on the lower scale of the graphic and the minimum level of the signal on the upper scale. To determine the number of the nearby utilities, you should step aside from the axis of the located cable and go straight across to the utility axis to visualise the amount and place of the route of utilities.

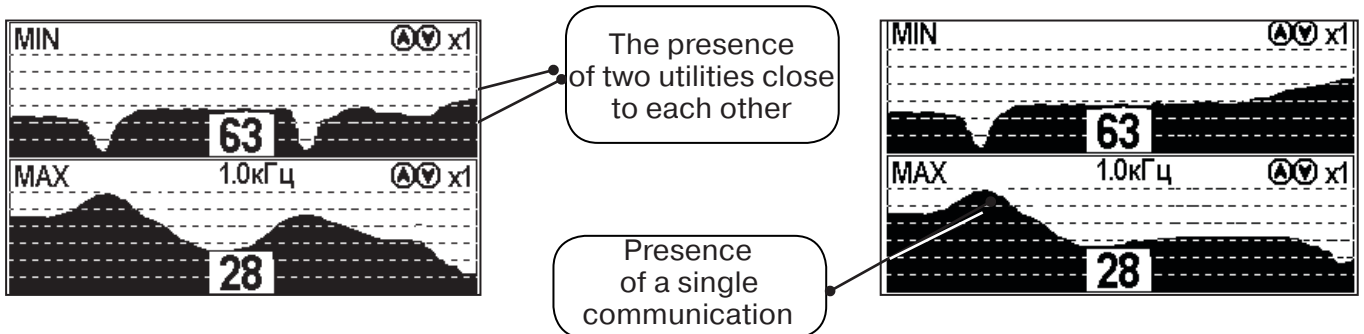

## 9. Performing Cable Route Location in “2 Frequencies” Mode

The mode “2 frequencies” was added so the user could determine the signal direction in cables.

**Additional possibilities of the mode are described in App. 2:**

Append. 2 p.3 Amplitude “two-frequency” method “ $\Delta A$ ”;

Append. 2 p.4 Phase “two-frequency” “ $\Delta\phi$ ”



**The mode “2 frequencies” is realised only with the contact method of connection of the transmitter.**

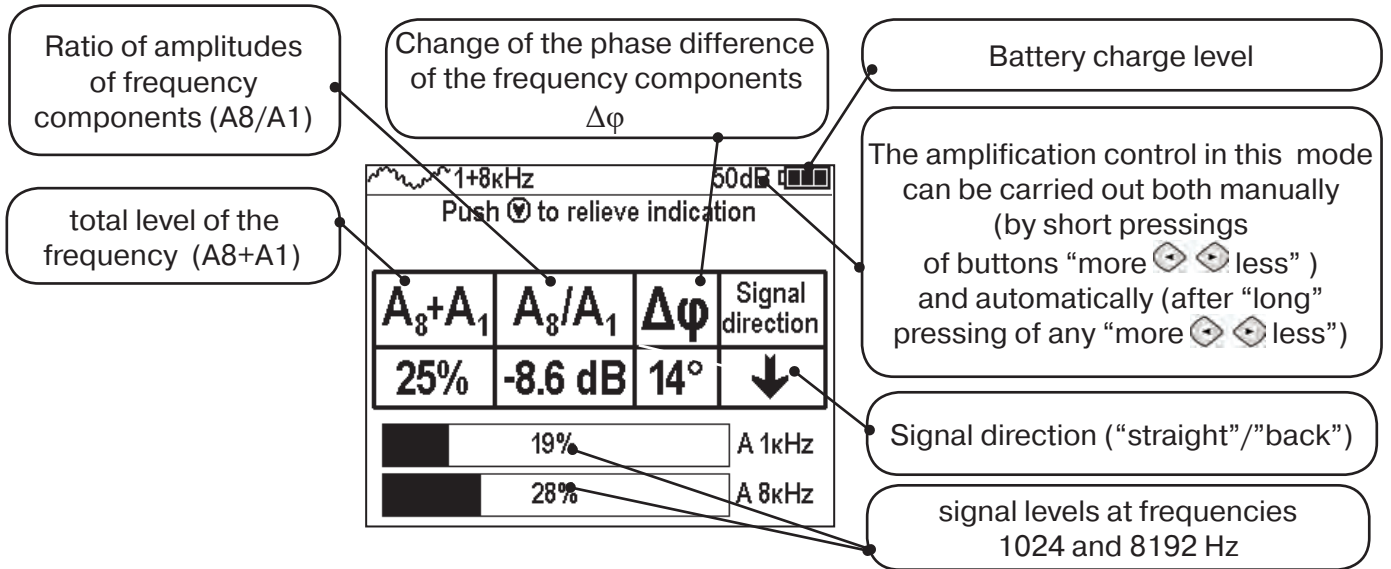

1. One output of the transmitter should be connected to the point of the utility that is more distant from the supposed place of the defect (start of the diagnostic site). The other output of the generator is grounded on the maximum possible distance from the utility from the other side (end of the diagnostics site). The buried service should be earthed (or grounded) as far away from it as possible.

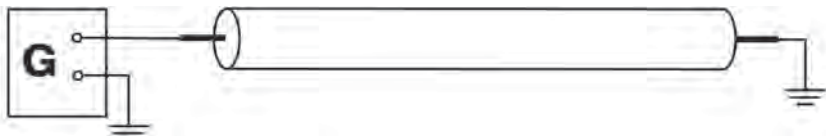
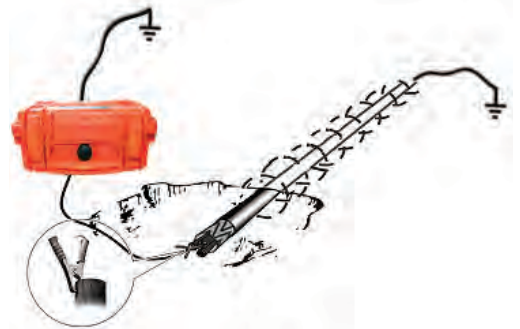

2. The transmitter in the mode “2F” sends to the utility the signals of two frequencies (1024Hz and 8192Hz) simultaneously.

3. The signal from the utility, to which the route locating transmitter is directly connected, is conventionally named - "friend". The "parasitic" signal from the nearest utility, on which the generator signal is transferred, is conventionally named as "somebody else's".

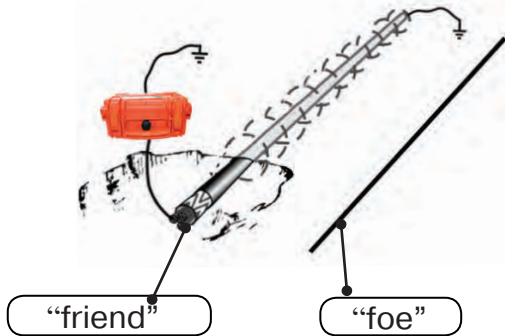

4. Based on the direction of the "arrow", it is possible to distinct a "friend" signal from a "foe" one, since the current direction in "friend" utilities is opposite the "transferred" currents flowing through "foe" utilities.

$A_8+A_1$	$A_8/A_1$	$\Delta\varphi$	Signal direction
34%	-0.1dB	-2°	↑
16%		A 1kHz	
18%		A 8kHz	

5. "Signal direction - forward" is the conventional concept and "assigned" by the operator, for this position of the sensor relative to the route. The "assignment" is performed by the pressing of the button "⏸"; when the sensor is located exactly over the "allocated" utility that is supposed to be a "friend". After that, the pointer of the signal direction takes the form - 1.

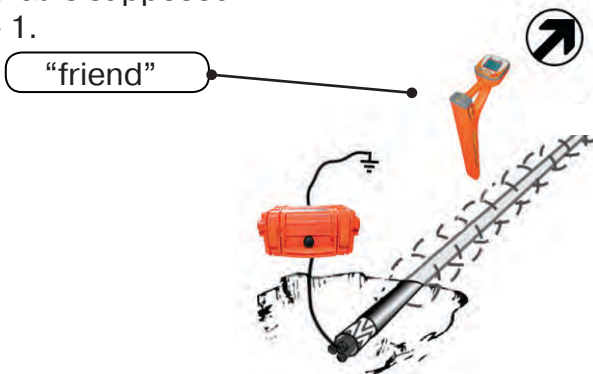

$A_8+A_1$	$A_8/A_1$	$\Delta\varphi$	Signal direction
34%	-0.1dB	-2°	↑
16%		A 1kHz	
18%		A 8kHz	

When switching to the "foe" communication with the other "signal direction" (or at the change of the sensor position to the "reverse"), the sound will be emitted (if switched on) and the arrow will show the "signal direction - back 1".

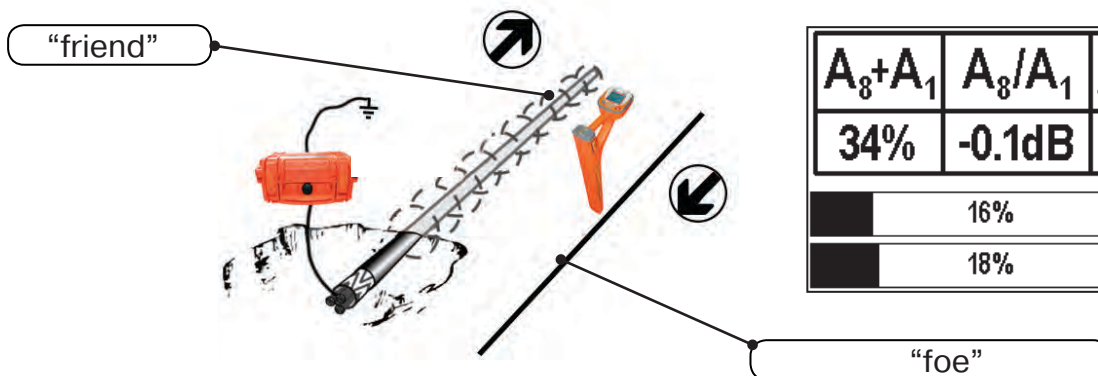

$A_8+A_1$	$A_8/A_1$	$\Delta\varphi$	Signal direction
34%	-0.1dB	-2°	↓
16%		A 1kHz	
18%		A 8kHz	

## 10. The work mode «Cable selection from a bunch»

The mode «Cable selection from a bunch» is switched on and off automatically with the connection and disconnection of the external sensor (**ES**) **CI-105/110** (inductive clamps) or **NP-117** superimposed frame).

The mode is intended for selection of the «allocated» cable from the bunch of cables on the basis of maximum signal emitted by this cable. The selection can be carried out at all the frequencies supported by the receiver.

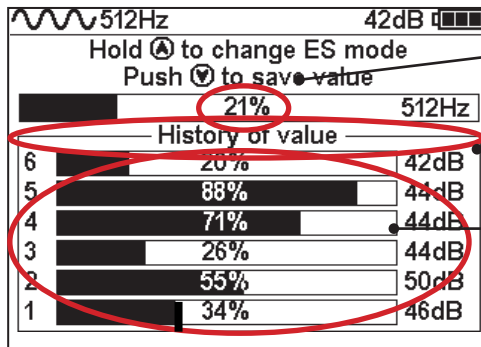

The level of the filtered signal from the sensor CI-105/110 or NP-117 in percentage

The current level of the signal and the amplification coefficient for the moment of measurement

Six lines for signal level and amplification coefficient values stored by the user. At each storage the content of all lines moves by one position down

### 10.1. The work with the receiver in the mode «Selection of the cable from a bunch»

**Attention!** In order to select the allocated cable from a bundle, you should provide the flowing of the current of the current on the set frequency and form through it. To do this, it is necessary send into the searchable cable the signal from the route locating generator by the contact or contactless method and provide the «current return» to the generator (for example, through the ground). All output ends of cables of the bunch should be connected to the «return» circuit.



Fig. 10.1



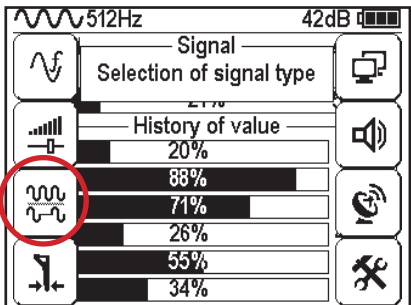

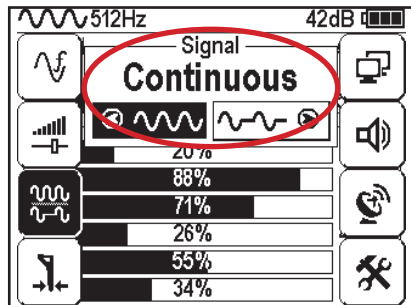



Fig 10.2







Connect inductive «clamps» CI-105/110 using the cable-adapter for «clamps» to the receiver (**fig. 10.1**) or NP-117 (**fig. 10.2**).

 Turn on the power	 Press 'Enter' button to open the menu	 Select «Filter» in the menu.	 To enter the change mode	 Set the working frequency, for example, 512 Hz (*)

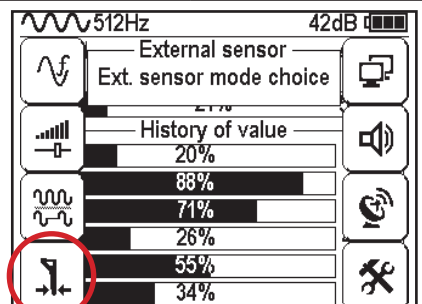
(\*) at that the signal should be sent into the cable from the transmitter with the same frequency 512Hz

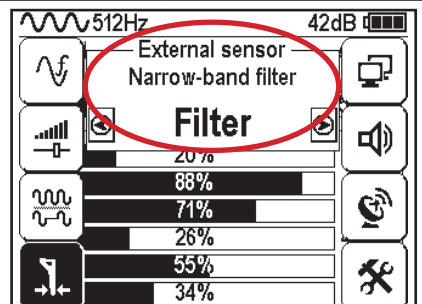

 <p>Press 'Enter' again to return to main menu.</p>		 <p>To confirm your selection press 'Enter' button.</p>		 <p>Press 'Enter' again to return to main menu.</p>
	<p>Select «Signal» in the menu.</p> 		<p>Select the signal type corresponding to the signal type from the transmitter, for example, continuous.</p> 	

	 <p>To enter the selection</p>		 <p>To exit from the menu you should press the button «Enter». If you will wait for several seconds, menu icons will disappear.</p>
<p>Select the icon «Mode of the lower sensor» in the window.</p> 		<p>Select the mode of the bottom sensor «Filter»</p> 	

Install on «induction clamps» CI-105/110/110 (fig. 10.3) or apply NP-117 (fig. 10.4) onto the one of cables.



Fig. 10.3

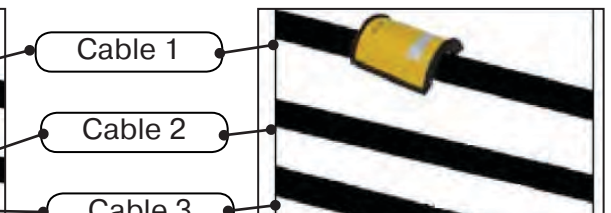

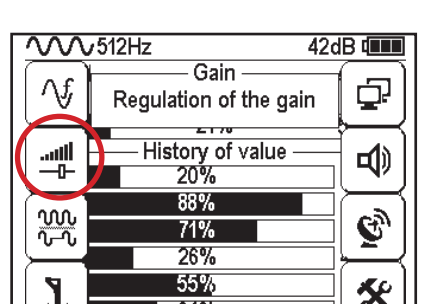

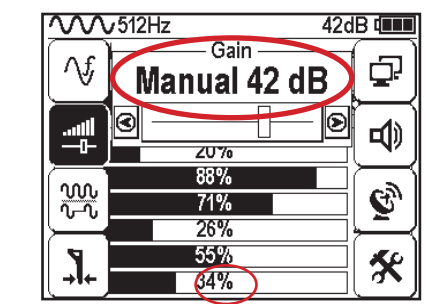



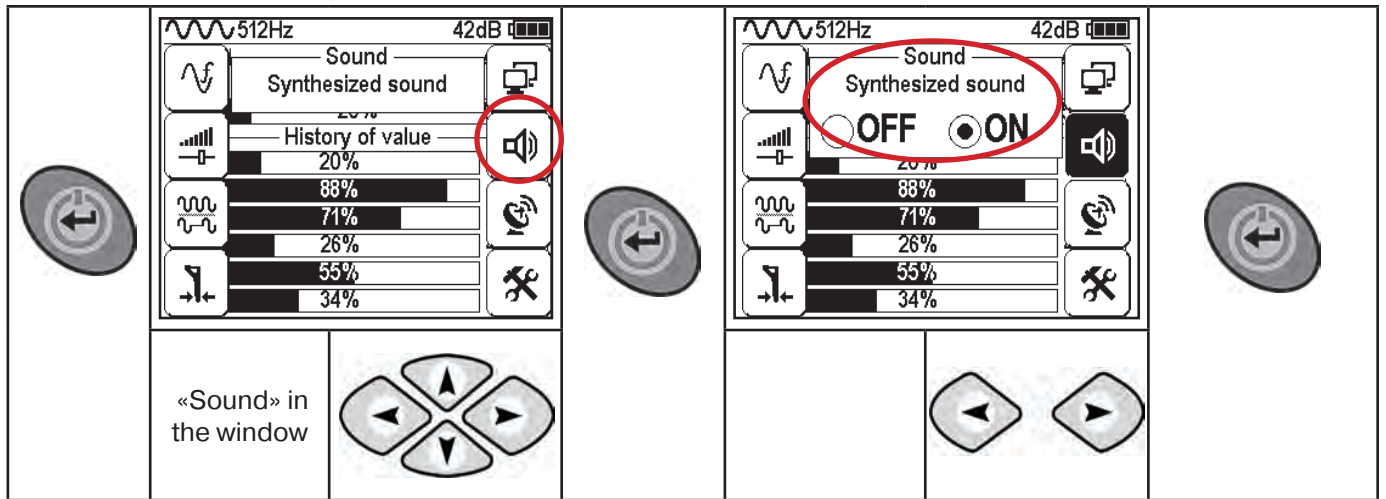

Fig. 10.4

 <p>Press 'Enter' again to return to main menu.</p>		 <p>To confirm your selection press 'Enter' button.</p>	 <p>the signal level on the bottom scale should be in the range 50 to 80%</p>	 <p>Press 'Enter' again to return to main menu</p>
	<p>Select «Amplification» in the menu.</p> 		<p>Set the amplification coefficient, for example, 40 dB</p> 	



**Save parameters of measurement into the memory by pressing the button**

Alternately putting on «Inductive clamps» or applying a attachable frame to the cables bundle, find «isolated» cable by the higher level of the signal (Fig. 10.5).

The tone pitch of the synthesised sound correspond to the signal value (including and «impulse» amplitude)

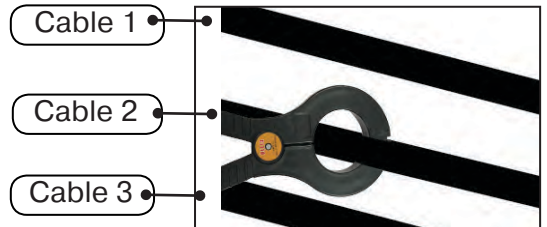

**Note**

To compare the signals, you should perform measurements at the equal amplification coefficient.

In the example (fig. 10.5) it is possible to compare values only with the amplification 42 dB. The maximum of them is the value under the number 5.

The maximum signal 80% (42 dB) corresponds to the cable No.2

	32%	512Hz
History of value		
6	38%	42dB
5	61%	42dB
4	48%	42dB
3	10%	32dB
2	27%	36dB
1	14%	36dB

**Fig. 10.5**

### 10.2. «Hot» keys for the work in the mode «Selection of the cable from the bunch»

step-by-step (by 2dB) decrease / increase coefficient of the amplification, sequential pressings

switching between modes of work of the external sensor (ES) is carried out by the holding of the button more than 1 sec. «WB» - range of frequencies 0.04..8 kHz «Radio» - range of frequencies 8, 40 kHz at absence of the value corresponds to the frequency of the set filter (here - 1,0 kHz)

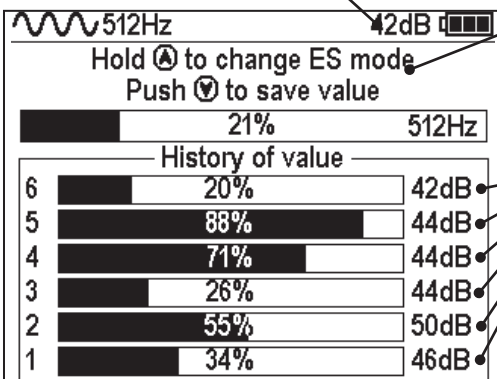

**The storage of the parameters of measurement (signal level from the sensor connected and amplification coefficient) into the memory using the button**  
(the memory keeps last six measurements)

**Note**

In the mode «Cable selection from a bunch» using the external sensor, the work with the continues and impulse signal is supported (menu option «signal», table 1 p.3). The difference at the work with the «Impulse» signal is in that the digit in the center of the analogous scale shows not the current value of the signal, but the maximum value (amplitude) of the transmissions of the interruptible signal from the route locating transmitter made by TECHNO-AC.

## 11. Mode «Search of defects» using external sensors

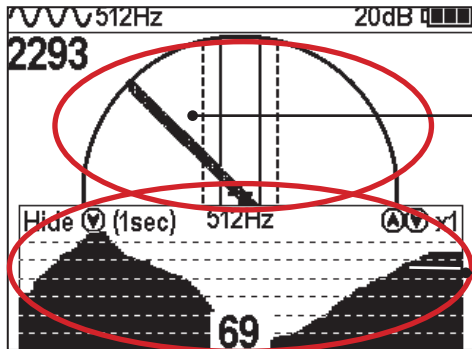

The mode 'Search of defects' is switched on and off automatically, when connecting and disconnecting external sensors DKI-117, DODK-117. The mode «Search for defects» with external sensors DKI-117/DODK-117 was added for search of insulation defects.

The search of defects of cable defects can be carried out at all frequencies both in an active, and passive modes.



2D display of the route location

2 The graphic of time change of the external sensor signal level

The graphic can be hidden by long pressing of the button  and appears at the short holding  of the button.

### 11.1. The work with the receiver in the mode «Search for defects»



Fig. 11.1



Fig. 11.2

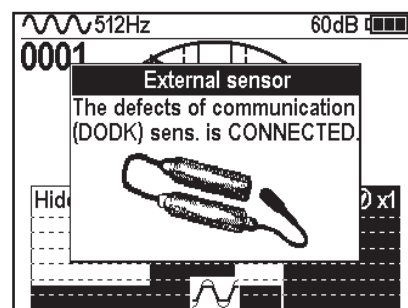
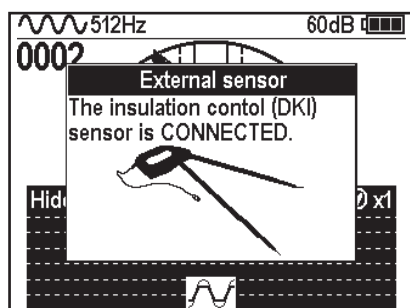

- Connect to the sensor to the receiver of the insulation control DKI-117 (fig. 11.1) or DODK-117 (fig. 11.2).

## Preparation of the sensors for work DKI-117

Prepare the sensor for operation.

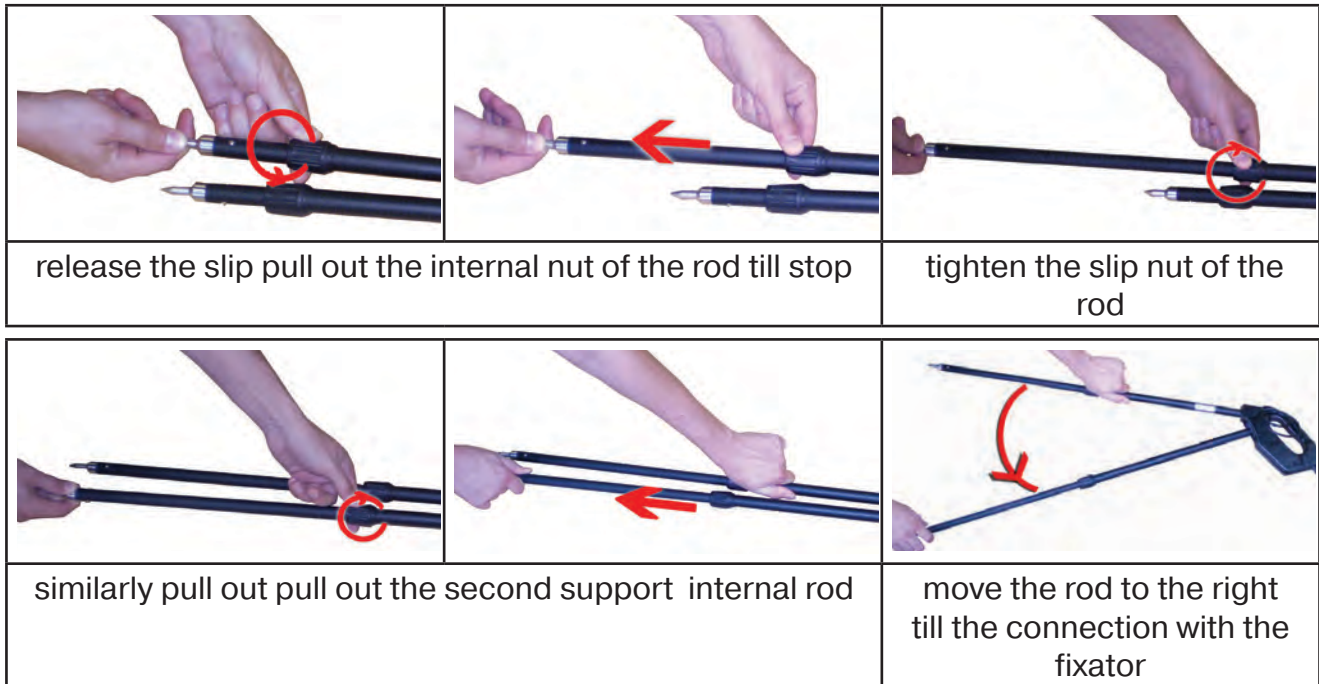

The average position of the fixator corresponds to the angle 30, end - angle 60 (fig. 11.3). Maximum distance between electrodes corresponds to the maximum sensibility.

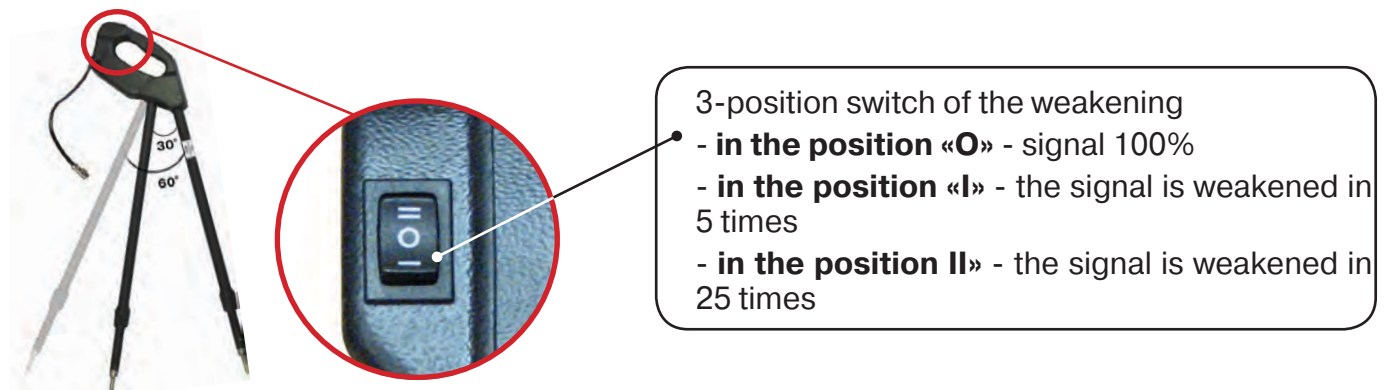

Fig. 11.3.

Before starting the operation you should set the switch into the position «O». If during the search process, with the amplification coefficient 0 dB, the input signal level is greater than 70%, you should switch the sensor regulator to «I» position and with a further increase of the signal to the position «II», and then perform the adjustment of the coefficient of amplification of the receiver to the level of the input signal 50 to 80%. (Fig. 11.4)

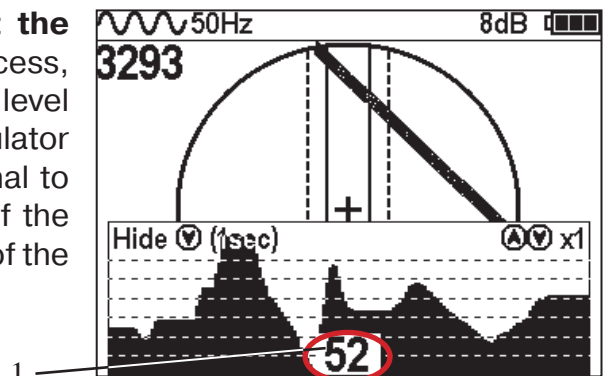

Fig. 11.4

## DODK-117

The survey shall be performed by two operators, the one operator has the measuring electrode, and the second one has the measuring electrode and receiver (fig. 11.5). Based on the receiver indications, you can locate the damaged cable (by methods described in the application 2 p. 1-2).

### NOTICE!

**When working with the sensor DODK, the electrodes should be used without gloves, providing the contact of the sensor with a skin (fig. 11.6)**



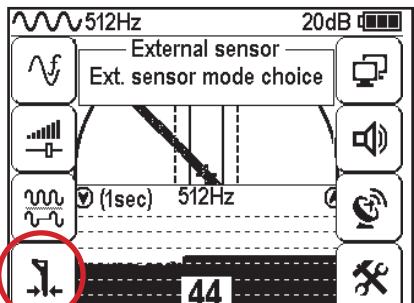

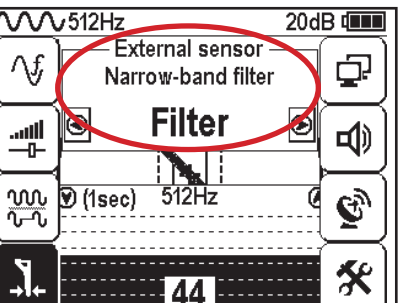

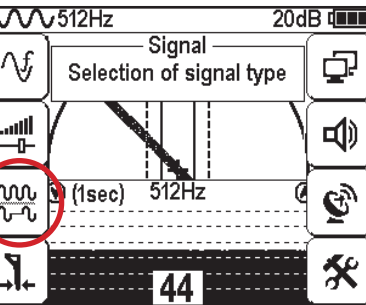

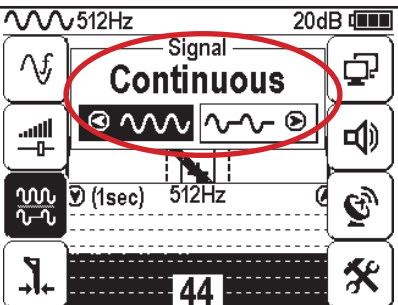

Fig. 11.5







Fig. 11.6

### Receiver setting

1. Turn on the receiver
2. Set the work mode of the lower sensor to the value «Filter»
3. Set the working frequency and type of the signal:

 <p>To call out of the menu press the button «Enter»</p>	 <p>Select the icon «Mode of the lower sensor» in the window.</p> 	 <p>To change of the parameter selected, press the «Enter» button.</p>	 <p>Set the value signal «Filter»</p> 
 <p>To exit the change mode</p>	 <p>Select the icon «Signal» in the window.</p> 	 <p>To enter the change the parameter selected, press the «Enter» button.</p>	 <p>To exit the setting of the parameter, press the «Enter» button.</p> 

 To call out of the menu press the button «Enter»	 Filter Center frequency of a filter	 To change the parameter selected, press the Enter button.	 Filter <b>512 Hz</b>
	Select the icon «Filter» in the window.		

**Wait for several seconds till menu icons disappear**

The search of insulation damage should be started by the method «MAX» (fig. 11.7, 11.8) (see. appendix 2). Move along the cable axis, mark the place cable signal (start of the signal rise, place of the maximum detection).

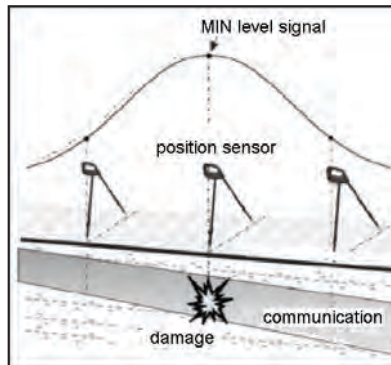



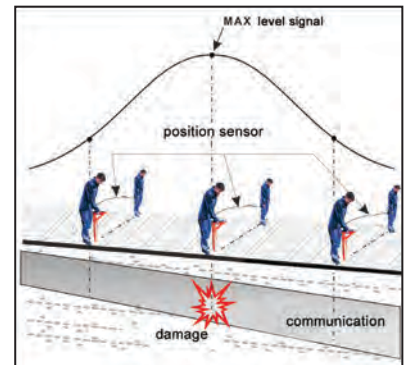



(fig. 11.7.)



(fig. 11.8.)



When working with sensors you should regulate the receiver amplification coefficient so that the signal level was in the rang 50 to 90 %.

 To call out of the menu press the button «Enter»	 Gain Regulation of the gain	 To enter the mode of the arameter selection, press the «Enter» button.	 Gain <b>Manual 20 dB</b>	 To exit the setting of the parameter, press the «Enter» button.
	Select the icon «Amplification» in the window.			

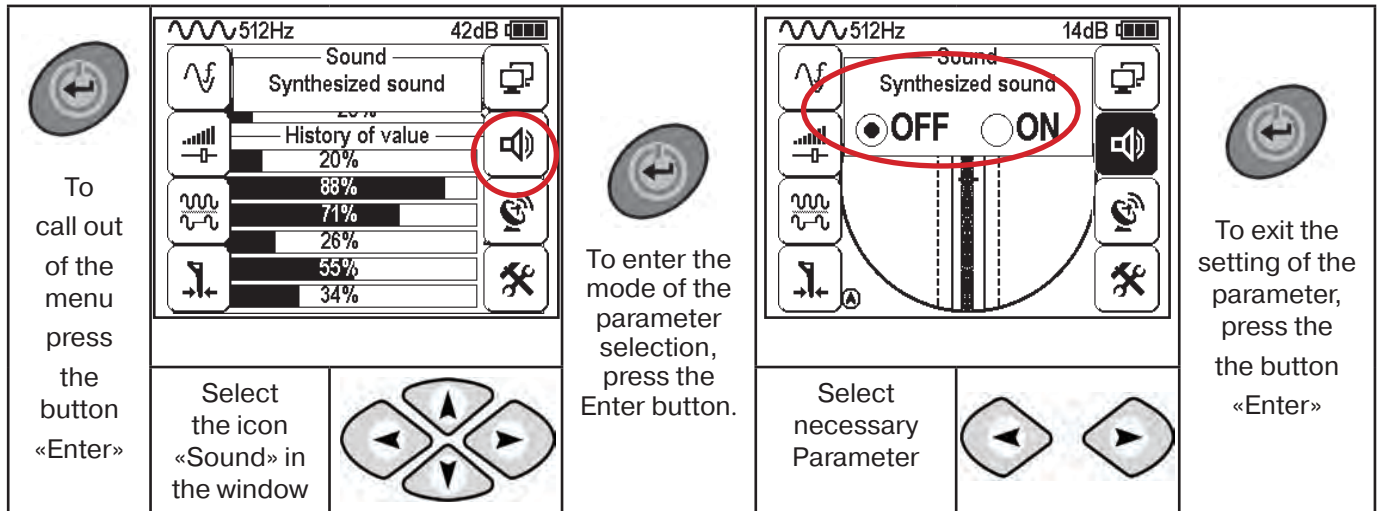
The user can listen synthesized sound through the built-in sound speaker. The sound tone pitch changes depending on the signal level. The synthesized sound can be switched on in the menu «Sound».





### 11.2 «Hot» keys for work in the «Graph» mode with DODK and DKI

step-by-step (by 2dB) decrease / increase coefficient of the amplification: semi-automatic of suitable gain by pressing "down" button for 1 second  

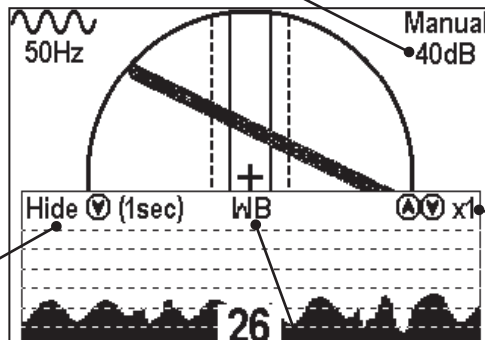
switching off the «Graph» mode and switching to the Route mode by holding the button for more than 1 sec 



increase/decrease of the image x1, x2, x4, x8 by the short pressing of the buttons:  

This part of the screen shows the advanced bottom sensor mode: WB - Wide Band (F up to 8kHz); Radio - F more than 8 kHz; To switch the mode, press the button: 

User can hear synthesized sound via built-in speaker. Sound pitch will change in accordance with signal level. You can enable this feature in "Sound" menu.

#### NOTE

In the mode «Search of defects» using the external sensor, the work with the continues and impulse signal is supported. The difference is in that the digit in the center of the analogue scale shows not the current value of the signal, but the maximum value (amplitude) of the transmissions of the interruptible signal from the transmitter. Without changing the gain coefficient (gain coefficient should be the same as in the place of maximum signal) you should change to initial point and survey the area of maximum signal again. Try to find local maximums (places where the signal grows then decreases and grows again). Locate the main maximum.

The presence of local maximums indicates that there are several places with damaged insulation which are placed closely to each other. It is advised to wright down the signal levele of the places with 'normal' signal level and the places where the signal reached its maximum. The range of signal increase usually correlates to the scale of damage.

## Appendix 1 Receiver AP-019.1 Specifications

Parameter	Value
Receiver filter centre frequency	Switching 50(60)/ 100(120)/ 512/ 1024/ 8192 / 32768 Hz
«Wide band»frequency band	0,04...8 kHz
Frequency range "Radio"	8...40 kHz
Maximum amplification factor of the electric path	120 dB
Dynamic range of the input signal	100 dB
Number of embedded sensors	4
Max. Sensitivity	5 mkA at 1m distance (at 33 kHz)
Selectivity	$Q_{-3dB} > 100$ , stopband supression up to 120 dB
Sensors type	Inductive
Sensitivity control	Auto - for 2D display «Route». Semi-automatic or manual (optional) - for the «Graphics». Automatic or manual (optional) - for the «2F» mode.
Determination the burial depth of the route	Automatically in «Route» mode 0...9,99 m
Laying depth identification accuracy	±5%
Identification of the effective current in the route	Automatically in «Route» mode 0.001...49,99 A
Accuracy of current measurement of received signal	±5%
Support of energy saving (intermittent) modes of the route locating generators	At combined work with the route locating generators made by "TECHNO-AC" ("Pulse" mode)
Visual indication	Graphic display LCD display, 320x240 pix., with LED backlight
Induced parameters	-parameters of setting and control - 2D visualization of the route location relative to the device -graphics of the signal level from sensors - route burial depth - signal current
Audio indication	Headphones: -natural filtered sound
	Built-in transmitter - synthesized sound FM-sound indication of buttons pressing
Permissible impedance of the headphones	min.32 Ohm
Power source	4...7 V (4 type C batteries)
Time of continuous operation from the single battery set	Not less than 20 hours
Automatic shutdown when the device is not active	After 30 minutes of inactivity
Operating /storage temperature range	-20...60 / -30...60°C
Dust and water protection degree	IP54
Dimensions	330x140x700 mm
Weight	2,4 kg



## Appendix 2 Searching methods by AP-019.1

### 1. MAX method when searching the place of insulation damage with sensors DKI-117 and DODK-117

When searching for insulation damage by «MAX» method, the one of the input terminals (contact pins of DKI or electrodes of DODK) should be placed over the route, and the second one - at a maximum distance from the route, in the direction straight across its axis.

While moving along the route, the operator dips the contact pins in of DKI sensor in the ground. The measurements will be correct while the contact pins are firmly dipped into the soil.

DODK electrodes are transported by the two operators located from each other at the distance equal to the length of the connecting wire. In this case, measurements can be made continuously in motion.

The signal gradually increases when approaching the spot of damage, reaches it's maximum when one of the contact electrodes is above the damage spot and then gradually decreases (**fig.A. 1**).

The MAX method can reliably detect the existence of damage, however, has a low accuracy of localization of the exact place due to the blurred indication of signal curve maximum.

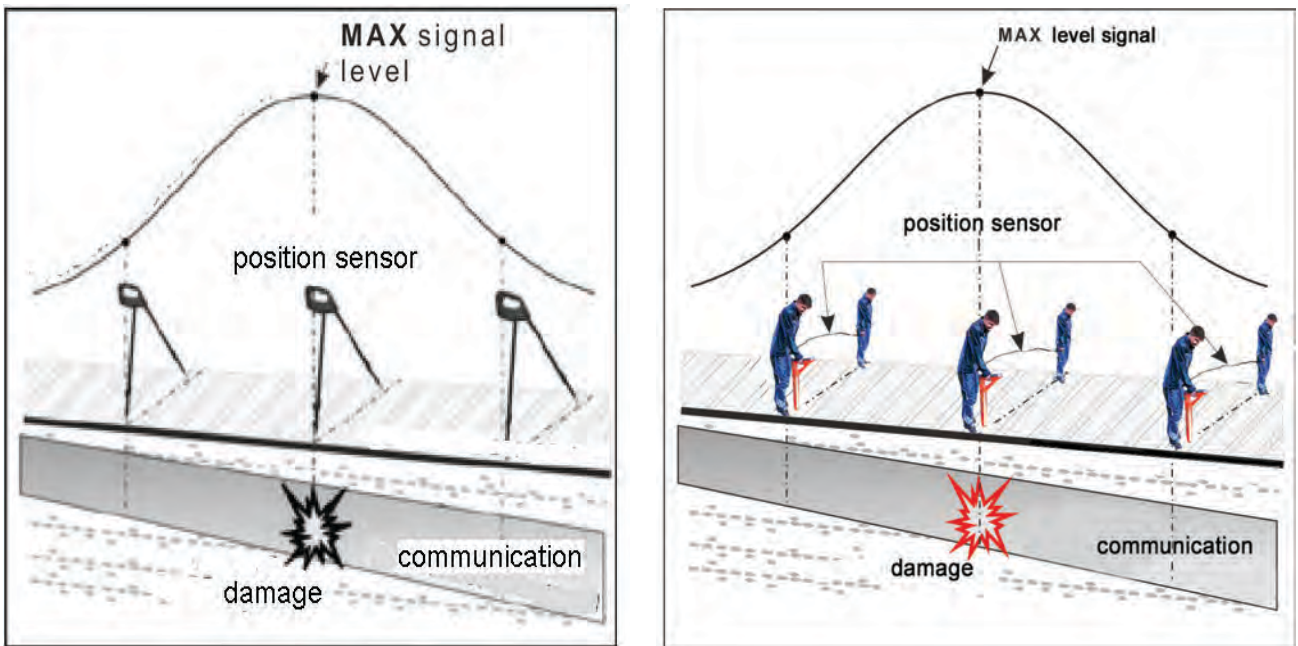

**Fig. A. 1**

## 2. Method MIN when searching the place of damage location using sensors DKI-117 or DODK-117

When searching for insulation damages by «MIN» method, the contact pins of DKI-117 or DODK-117 electrodes should be placed over the route, along the axis of the route. When you use the MIN method, the signal increases smoothly at first, then rapidly decreases to a certain minimum value, then as the distance from the damage place increases, it rises sharply again and then gradually decreases.

The place of damage will be located midway between the electrodes, at a time when the signal reaches the minimum value (**fig. A.2**).

The sensor DODK-117 provides a «fast» method of damage location, which is especially important for the extensive communications, and the sensor DKI-117 provides a higher sensitivity and accuracy of damage location and needs only one operator for work with it.

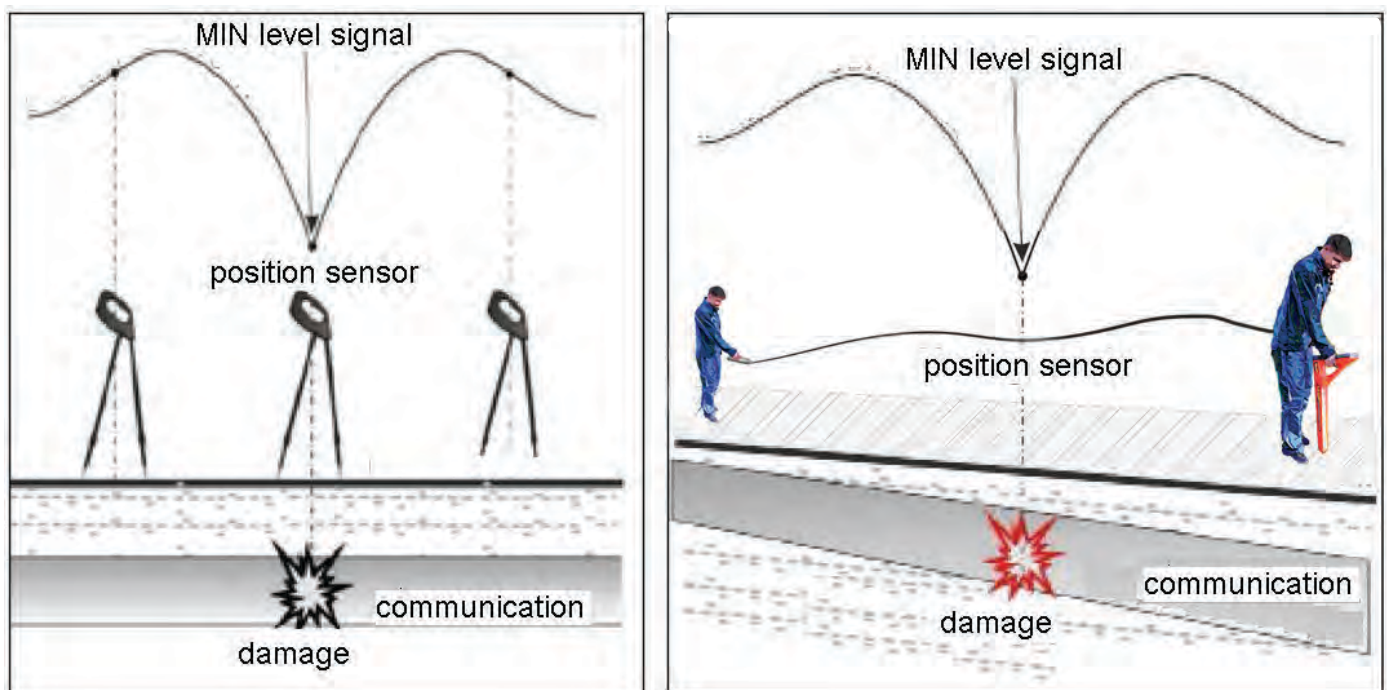





Fig. A.2

### 1. Amplitude “two-frequency” method “ΔA”

This method was added for contactless search of insulation defects of city cables with resistance less than 5 kOhm. The smaller the distance to the end of the cable, the higher the sensitivity of the method on this site.

**The method description:** the two-frequency signal is transmitted from the generator. The ratio of two-frequency signal amplitudes remains stable if there is no damage to the cable. In the presence of damage, the ratio of amplitudes in the place of damage is changed.

**Table 8**

 <p>1. 1. Exit output of the generator should be connected to the “start” of utility (more distant from the supposed place of the defect). The other output of the generator is grounded on the maximum possible distance from the utility. The “end” of the utility is not grounded.</p> 	<p>1. 1. Exit output of the generator should be connected to the “start” of utility (more distant from the supposed place of the defect). The other output of the generator is grounded on the maximum possible distance from the utility. The “end” of the utility is not grounded.</p>	<p>2. The transmitter in the mode “2F” sends to the utility the signals of two frequencies (1024Hz and 8192Hz) simultaneously.</p>																
<p>3. The defect localisation is performed in direction “from generator”.</p> 	<p>4. The value “A8/A1” is sharply changes, when operator passes the place of leakage of the signal current into the ground.</p> <table border="1" data-bbox="890 1205 1300 1400"> <thead> <tr> <th><math>A_8+A_1</math></th> <th><math>A_8/A_1</math></th> <th><math>\Delta\varphi</math></th> <th>Signal direction</th> </tr> </thead> <tbody> <tr> <td>34%</td> <td>-0.1dB</td> <td>-2°</td> <td>↑</td> </tr> <tr> <td colspan="3">16%</td> <td>A 1kHz</td> </tr> <tr> <td colspan="3">18%</td> <td>A 8kHz</td> </tr> </tbody> </table> <p><b>NOTE</b> A8/A1 indication can have negative value. In such cases, it recommended to reset indication periodically, using the button .</p>	$A_8+A_1$	$A_8/A_1$	$\Delta\varphi$	Signal direction	34%	-0.1dB	-2°	↑	16%			A 1kHz	18%			A 8kHz	
$A_8+A_1$	$A_8/A_1$	$\Delta\varphi$	Signal direction															
34%	-0.1dB	-2°	↑															
16%			A 1kHz															
18%			A 8kHz															
<table border="1" data-bbox="108 1585 526 1825"> <thead> <tr> <th><math>A_8+A_1</math></th> <th><math>A_8/A_1</math></th> <th><math>\Delta\varphi</math></th> <th>Signal direction</th> </tr> </thead> <tbody> <tr> <td>34%</td> <td>-0.1dB</td> <td>-2°</td> <td>↑</td> </tr> <tr> <td colspan="3">16%</td> <td>A 1kHz</td> </tr> <tr> <td colspan="3">18%</td> <td>A 8kHz</td> </tr> </tbody> </table>	$A_8+A_1$	$A_8/A_1$	$\Delta\varphi$	Signal direction	34%	-0.1dB	-2°	↑	16%			A 1kHz	18%			A 8kHz	<p>5. The “double” scale shows levels (amplitudes) of the frequency components of the signal. At bottom - “A8kHz”, at top - “A1kHz”. When levels of the frequency components are insufficient for determination “<math>\Delta\varphi</math>”, the inscriptions “A8kHz” and “A1kHz” are correspondingly “darkening”, and the value “X.XdB” disappears.</p>	<p>6. There is no need to continuously move along the route, controlling the signal. You can walk around the place which is hard to reach. If, while returning to the route, A8/A1 did not changed, it means that there are no damages on the surveyed site.</p>
$A_8+A_1$	$A_8/A_1$	$\Delta\varphi$	Signal direction															
34%	-0.1dB	-2°	↑															
16%			A 1kHz															
18%			A 8kHz															

7. The sharp positive overfall of the “A8/A1” value by 3dB and more indicates the possibility of defect existence (the resistance is less than 5 kOhm). The sensor should be located straight across the utility.

$A_8+A_1$	$A_8/A_1$	$\Delta\varphi$	Signal direction
34%	4.4dB	-2°	↑
16%		A 1kHz	
18%		A 8kHz	

If you go through the same site in the opposite direction (towards the generator), holding the receiver the same as before with reset of the indication (using the button ) , negative values of the reading (more than minus 3dB) will mean that there is damage in the cable.

## 2. Phase “two-frequency” Method “ $\Delta\varphi$ ”

The contactless method of search for insulation defects of city cables with resistance less than 10 kOhm. The smaller the distance from the end of the cable, the higher the sensitivity of the method on this site. This method cannot be used in a city because of high distortion of the signal.

Steps 1-3 are similar to those in p.3.

$A_8+A_1$	$A_8/A_1$	$\Delta\varphi$	Signal direction
34%	4.4dB	14°	↑
16%		A 1kHz	
18%		A 8kHz	

4. “ $\Delta\varphi$ ” shows the change of the phase difference “ $\varphi_{1024} - \varphi_{8192}$ ”, after the resetting (in degrees reduced to the frequency 1024 Hz). The value “ $\Delta\varphi$ ” sharply changes, when the operator passes the place of leakage of the signalling current into the ground.

### NOTE

$\Delta\varphi$  indication can be negative, “running” in the process of increase of distance from the generator. It is recommended to periodically reset such indications (exactly over the route), using the button .

$A_8+A_1$	$A_8/A_1$	$\Delta\varphi$	Signal direction
34%	-0.1dB	-2°	↑
16%		A 1kHz	
18%		A 8kHz	

5. The “doubled” scale shows levels (amplitudes) of the frequency components of the signal. At bottom - A8kHz, at top - A1kHz. When levels of the frequency components are insufficient for determination A8/A1, the inscriptions A8kHz and A1kHz are correspondingly “darkening”, and the value “X0” disappears.

6. There is no need to continuously move along the route, controlling the signal. You can walk around the place which is hard to reach. If, while returning to the route, A8/A1 did not change, it means that there are no damages on the surveyed site.

The sharp positive overfall of the « $\Delta\varphi$ » value by 5° and more indicates the possibility of defect existence (the resistance is less than 10 kOhm). The sensor should be located straight across the communication.

$A_8+A_1$	$A_8/A_1$	$\Delta\varphi$	Signal direction
34%	4.4dB	14°	↑
16%		A 1kHz	
18%		A 8kHz	

If you go through the same site in the opposite direction (towards the generator), holding the receiver the same as before with reset of the indication

(using the button ) , negative value of the reading (more than minus 5°) will mean that there is damage in the cable.

To validate the existence of the damage, use contact method, using. Append. 2 p.1,2)

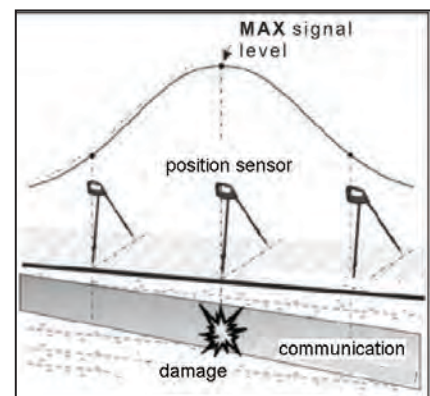

### Appendix 3 Area Survey Before Excavation Works

First of all, the area should be surveyed with the receiver in passive mode, in order to locate the signal from energised power cables, pipes with cathodic protection or any other current providing utility. To do that, use the following frequencies consequently: 50 Hz, 100 Hz, Radio and Broadband mode. Area survey in broadband frequencies should be performed in “MIN & MAX” mode, in lower sensor mode WB (0-8kHz) and Radio (over 8kHz).

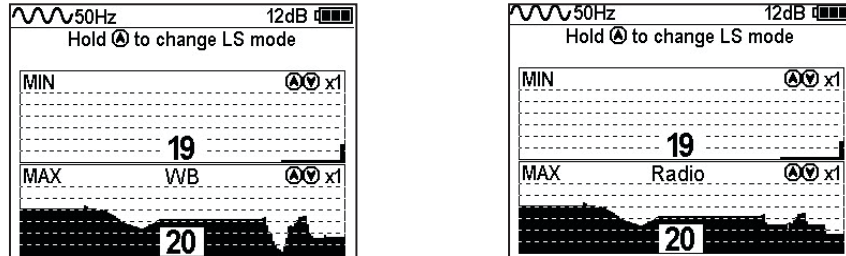

In this case, the operator should rely on “MAX” scale.

At 50 a 100Hz frequencies in Route mode, the signal strength will increase as you are moving to the utility. The following indication should appear on the screen while performing these actions:

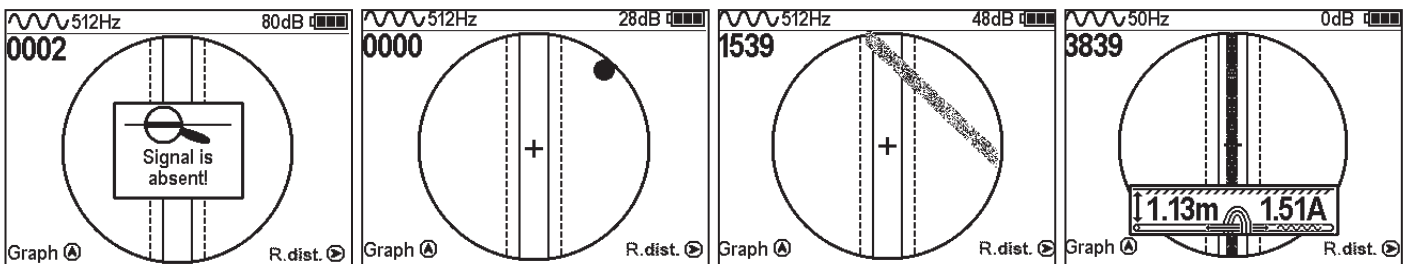

First make sure that there is no utility in the centre of the surveyed area. To do that, the operator with the receiver stands above the tested point and the second operator moves the transmitter around the first one. The radius should be 10-20m and the first operator should point the head of the receiver towards the second operator with the antenna.

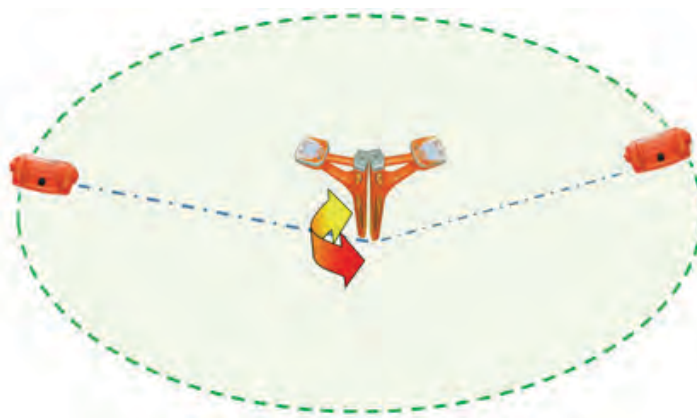

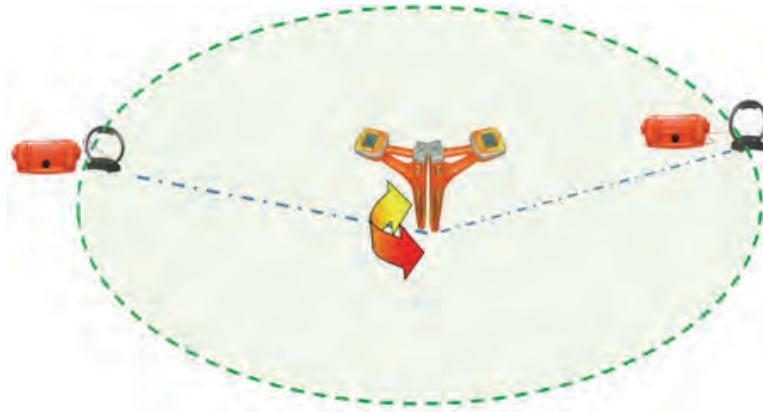

If there is no utility in center point of the area, then start the general location routine described below.

When surveying the area in active mode, it is necessary to place IEM-301.5 antenna horizontally in the center of the plot (you can remove the antenna from its stand). In this position the antenna will be in the flatness parallel to all surrounding utilities in the area.

After that it is necessary to connect the antenna to the transmitter and start the induction. Power of the transmitter should be set according to the size of the surveyed area (the smaller the area – the smaller the power).

Area survey in active mode should be carried out in “Graph” mode of receiver at the same frequency as had been set on the transmitter. Operator should move around the transmitter and perform to measurements at each point in two mutually perpendicular positions.

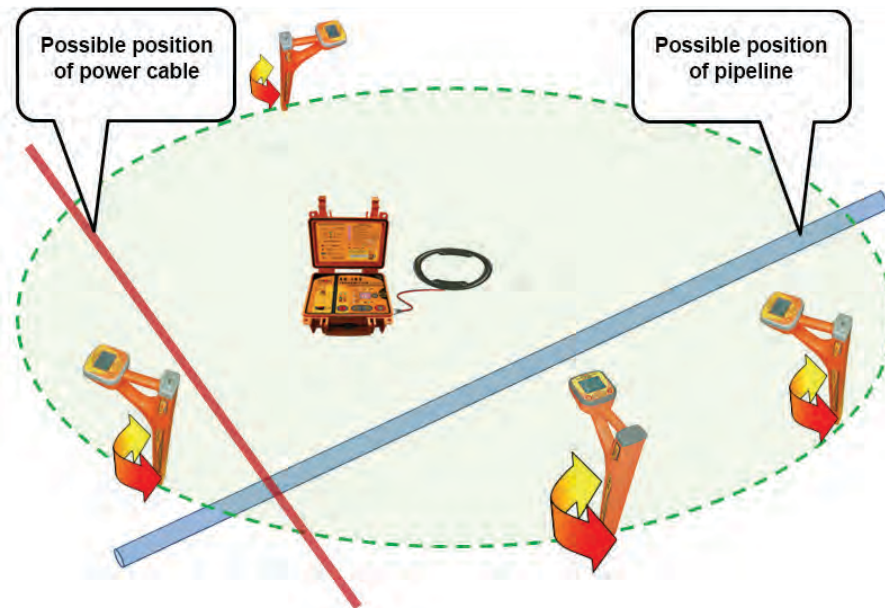

The presence of the utility will be indicated by the “signal strength” value (upper left part of display) or the graph in bottom part of the screen.

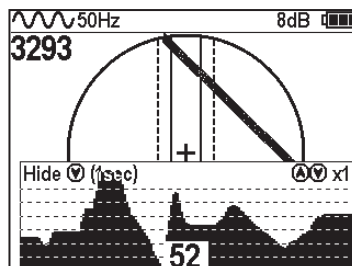

## Appendix 4 Operational features of the set

### **External influence during receiver operation**

Receiver's display readings can be incorrect while operating in distorted electromagnetic field. The cause of that may be in closely (approx. 3m radius) positioned metal objects (cars, metal fences, manholes and other utilities) and mobile phones.

If an important measurement is going to take place, please, try to exclude the influence of surrounding distortion.

### **Specialties of utility depth measurements**

During depth measurement process (if the utility axis indication is in the area of receiver screen, including its aligning with the axis of receiver) if the receiver is slightly moved aside the value of depth is increasing. That is why, true depth will be indicated by minimum value of depth indication.

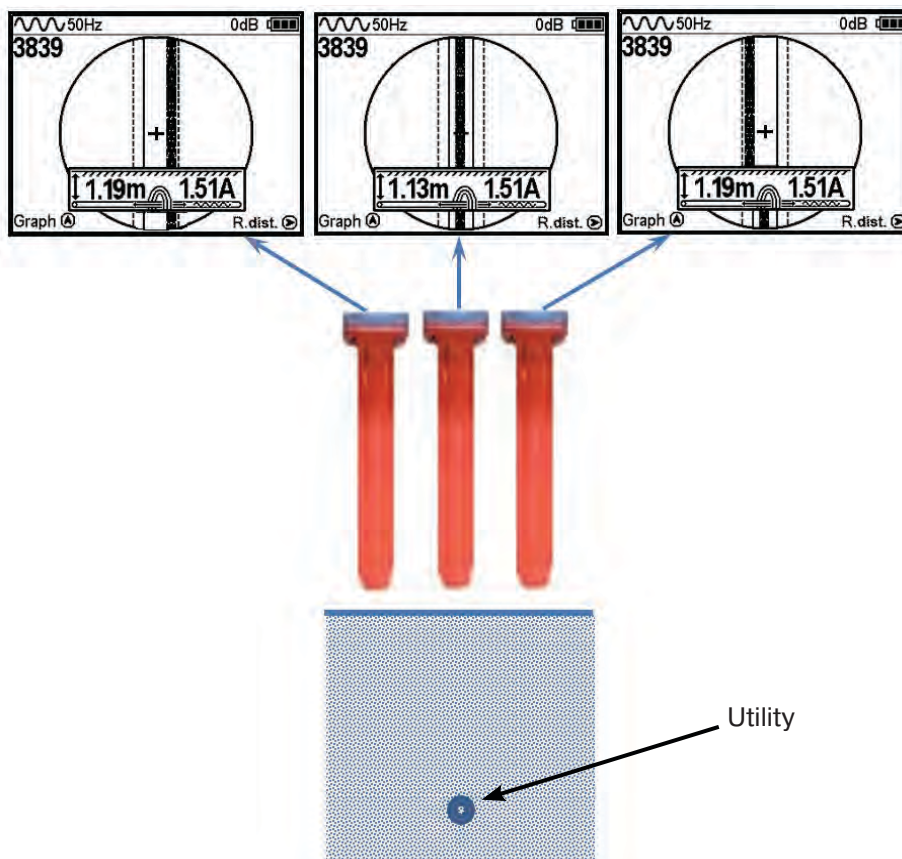

### **Receiver position during depth measurement**

Before measuring the depth of the utility, make sure that your device is positioned perpendicular to the utility. Even slight deviation from vertical position can influence the precision of depth measurement.

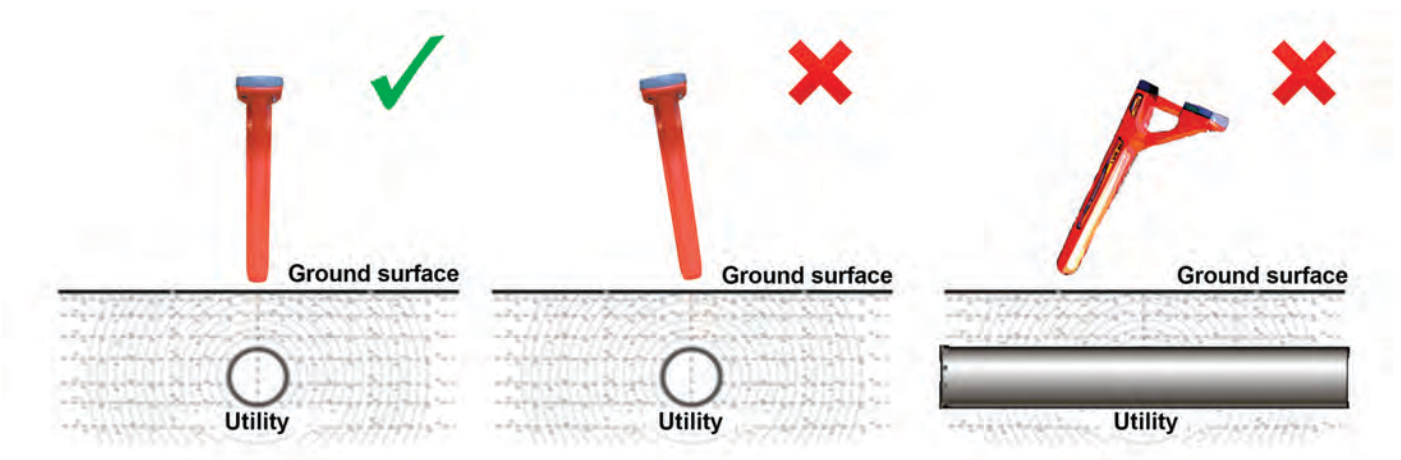

### **Operation via external power supply**

When operation is performed via external power supply, all internal power sources should be removed.

### **Specialties of utility location at 50Hz**

50Hz signal is used almost in every electric supply system in Russia and in most European countries. Energized cables create electromagnetic fields, which are induced to other conducting utilities (pipelines, dead cables)

From one side, this allows operator to locate both pipelines and cables in “Route” mode. Operator can define power cable and pipelines according to the depth (as a rule, average depth for cables is 0.6-1.0m; for pipelines 1.5m and more)

From other side, electromagnetic fields, created by current, induced on pipelines make tracing harder, especially in the areas with a lot of utilities in one spot. The receiver evaluates the position of the utility according to the resultant signal in a given spot.

When operating in passive mode on 50Hz frequency, in case of multiple utilities, the receiver can't tell which emits the signal. In this situation the values of depth can be incorrect.

It is important to understand that separate cables under voltage can create very weak electromagnetic fields and as a result almost absent resultant signal. It may be impossible to locate them in “Route” mode. Please, use “Graph” mode to identify the position of such cable.



## 11. Transmitter AG-105

**AUTONOMOUS • POWERFUL • PORTABLE • MEASURING**

### Device introductory information

#### 11.1. Purpose of Use and Physical Configuration

The transmitter AG-105 is an automatic utility locating transmitter designed for the generation of the propagating electric oscillations in the traces of the buried utilities using electromagnetic method of the trace search.

##### **Field of application:**

- Housing maintenance and utilities sector
- Communications industry
- Electric power and heat supply industries
- Gas supply

##### **The device is shown in the enclosure-case containing:**

- 1 - information panel on the inner side of the cover
- 2 - battery holder with the handle in the center for removing
- 3 - push-button and LED indication panel



#### **DISTINCTIVE FEATURES**

The extremely high output power and autonomous operating time for such a compact battery set (“type C”x8) and small size of the device.

The universal power supply provides an opportunity to reach the output power of over **20 W**. In the autonomous power supply mode, the “life cycle” depends on the quality of the batteries applied “type C”.

For example, under initial output power of **7 W** in the continuous oscillation mode, the “life cycle” is approximately 5 hours and under initial output power of **15 W** in the intermittent modulation mode, the “life cycle” is approximately **25 hours** (with the use of standard “fresh” batteries, e.g. “Energizer C”). Using high-capacity batteries (for example, “Duracell ULTRA”), the duration of the autonomous operation can be extended by 20-30%. If a “12V” external battery (e.g. automotive) is connected, the operation time is defined by the battery capacity. When connecting to the external power source of “15V”, the operating time is not limited.

The dimensions of the portable device in the casing are **216x180x105 mm** and weight does not exceed **2 kg**.

The above-mentioned features are secured by the application of the unique superefficient modification circuit technology of power amplifiers composition **CLASS D**. Pulse output amplifier reaches **85% efficiency**, which is particularly important for the energy consuming devices with an autonomous power supply.

**Transmitter AG-105 is the best-in-class of the “portable communication locating transmitters with low-powered autonomous power supply” in terms of the qualitative characteristics, namely power, operating life, dimensions & weight.**

The device generates a sine-shaped signal continuously “Co” or discontinuously “Pu” for utility (cables and steel pipelines) location and special dual-frequency signal “2F” for identification of “someone else’s” utility or for flaw detection of earth leakage.

Such a unique (among other transmitters) peculiarity as uncommonly high potential output current (more than **5 A**) make it possible to carry out utility locating of not quite adapted to such procedure the extraordinary low-resistance utilities (e.g. “earthed” pipelines) when the significant part of the output current inefficiently flows to earth already near the connection point.

The **Internal transmitting inductor** creates an intense electromagnetic field under relatively low energy consumption. There is the possibility of connecting the **external induction transmitting antenna** which produces intense emissions and provides immediate access to the “buried” utilities. An add-on **transmitting induction clamp** lets the induction of a current effectively into the specifically “chosen” utility from others nearby (inclusive of the one under voltage).

The transmitter AG-105 contains several **protection** levels against all sorts of unacceptable factors ensuring the highest level of reliability.

The internal “multimeter” displays the following readings according to the operator’s choice: **voltage, current, resistance, output power and power supply voltage.**

In the case of a decrease in “energy potential” (output voltage) of the power source during the oscillation process (for example, batteries self-discharge), the signal strength is automatically proportionally (incrementally) decreasing and consequently the consumed power. This program system extends the battery’s “life-cycle” considerably. Therefore, while searching **there is no premature “path loss”** and the decrease of signal level is offset by the options for the manual or automatic adjustment of the sensitivity of receivers made by «NPO TECHNO-AC» LLC.

The ingress protection rating of the casing is **IP65** which completely precludes any ingress of the dust or water jets when enclosed. The operating temperature range is **-30 C to +60°C** with the external (battery or mains supply).

## 11.2 Control and Indication Elements

### See - Appendix 3

#### 11.2.1 Display (functional fields of the front panel)

“**Electrical power supply field**” always displays rough estimates of the power supply. Source condition in the current mode operation using three coloured light emitting indicators.

1. The results of energy potent assessment of the power supply source (feasible operability index with current energy consumption level). Three categories of the output voltage of the power supply source “U” are determined under the specific value of the absorbed current in the actual operating mode:

1. The results of energy potent assessment of the power supply source (feasible operability index with current energy consumption level). Three categories of the output voltage of the power supply source “U” are determined under the specific value of the absorbed current in the actual operating mode:

- **green** colour of the indicator “U” – “nominal” voltage (high energy potential of the batteries or powerful external source).

- **yellow** colour of the indicator “U” – “acceptable” voltage (medium energy potential of the batteries).

- **red** colour of the indicator “U” – “cut-off” voltage (energy potential of the batteries almost used up, possible “unexpected” shutdown).

2) The category of the ABSORBED CURRENT “I” rate is specified based on the concordance between measured value of the current and the figure of the one of the three ranges specifically set by the program for the actual operating mode:

- **green** colour of the indicator “I” – “low” absorbed current.

- **yellow** colour of the indicator “I” – “medium” absorbed current.

- **red** colour of the indicator “I” – “high” absorbed current.

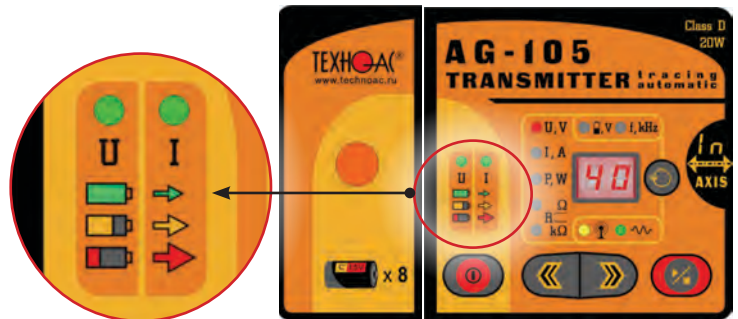

### Colour combinations “U ↔ I”.

The possibility in principle to raise the output signal level “U,V” depending on the combination of the indicators colours “U ↔ I” (if no other restrictions are in place)	Colour of the glow	
	“U”	“I”
<b>YES</b>	green	green
	yellow	green
	green	yellow
<b>NO</b>	yellow	yellow
	red	any
	any	red

#### NOTES for “Internal parameters field” and “Output parameters field”

- 1) **Red** colour of the glow of any indicator means that “oscillation” is in progress.
- 2) Parameter or mode the value of which is displayed in the “Digital field” in the “stop” passive mode is singled out by the flash of the relevant indicator.

#### 11.2.2 “Internal Parameters Field”

(In accordance with the operator choice) shows the numerical values of the following parameters in the “Digital field”.

- 1) POWER SUPPLY VOLTAGE in volts “**V**”:
  - the lack of the glow – another display parameter is chosen.
  - **green** colour glow – power supply voltage in the “stop” mode.

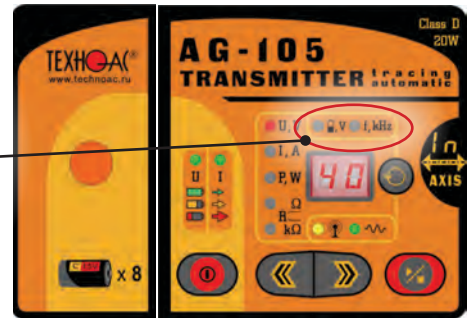

- **red** colour glow - power supply voltage “I”.

- 2) FREQUENCY of the generated signal in kilohertz “**f, kHz**”:
  - the lack of the glow – another display parameter is chosen.
  - **green** colour glow in the “stop” mode – the set frequency of the output continuous “Co” or pulse “Pu” signal is indicated in the “Digital field”.

#### 11.2.3 “Output Parameters Field”

(only in “oscillation” mode) at the choice of operator signifies via **red** colour the value of the specific output parameter that is indicated in the “Digital field”:

- “U,V” - output voltage in volts.
- “I,A” - load current in amperes.
- “P,W” - load power in watts.
- “R,Ω” - load resistance in ohms.
- “R,kΩ” - load resistance in kilohms.

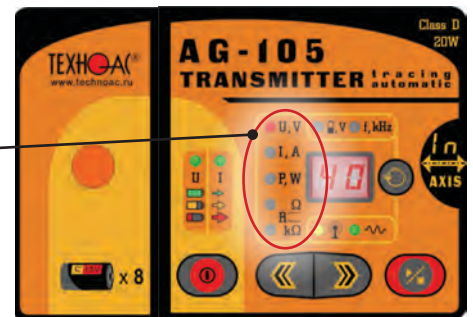
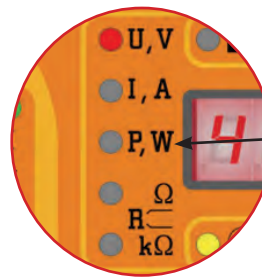

#### NOTE

In “antenna” mode “In” the only value available is “U,V”.

### 11.2.4 “Modes Field”

(In accordance with the operator choice) shows operating modes under various load types and different “modulation” options of the output signal.

1) “ANTENNA” - on / off “ANTENNA” mode and type of connection of transmitting antenna:

- the lack of the glow – earrings or clamp are connected to the output (there is no transmitting antenna).

- **green** glow – no equipment is connected to the output, internal transmitting inductor is only operable “In”.

2) “MODULATION” - on / off “MODULATION” (special form signal) and type of the special form:

- the lack of the glow – no modulation (continuous signal “Co” of the “regular” sine form);

- **green** glow – pulse modulation mode “Pu”;

- **yellow** glow – dual-frequency modulation mode “2F”.

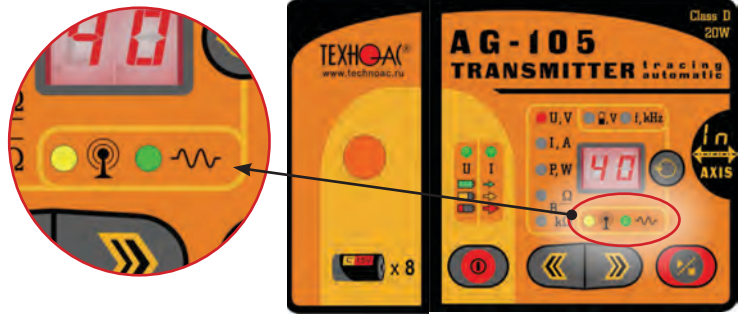

#### NOTE

“Modes field” always indicates information about the set operating modes irrespective of whether oscillation process is running or stopped due to non-use of the red colour (the colour signifying the “oscillation” mode).

### 11.2.5 “Digital field”

at the discretion of the operator displays either **numerical** parameter value (power supply voltage “U,V” / signal frequency “f,kHz” / output voltage “U,V” / load current “I,A” / load power “P,W” / load resistance “R,Ω / kΩ”) **or symbolic** notation of the mode:

“In” - internal transmitting inducto.

“Co” - continuous oscillation mode.

“Pu” - pulse modulation mode.

“2F” - dual-frequency modulation mode.

The type of the displaying value in the “Digital field” is defined by the CHOICE button and indicated by the glow of the relevant indicator in one of the surrounding functional fields.

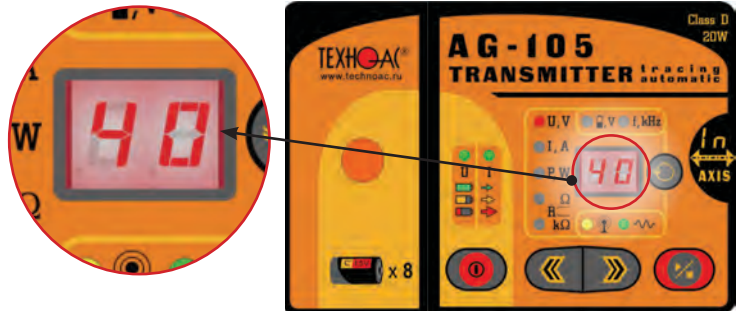

### 11.2.6 Control Buttons

POWER “I” by sequenced presses, the electrical power supply of the device can be switched on and off.

CHOICE “O” by sequenced presses, PARAMETER or MODE indication can be chosen to be shown in the “Digital field”.

MORE / LESS “<>” by sequenced presses, the parameter (mode) in the “Digital field” set by the CHOICE button “O” can be decreased / increased (adjusted).

START/STOP “/” by sequenced presses the device can be switched from “stop” to “oscillation” mode and back.

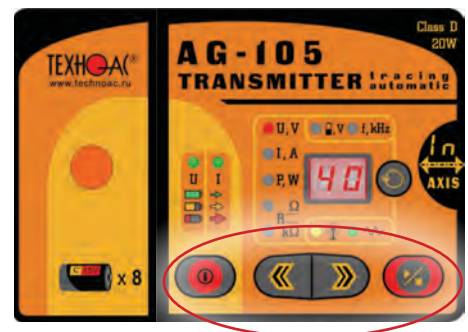

### 11.3. Ways of External Commutation

**Three-pin connector  
“EXTERNAL SUPPLY”**

For battery supply or main supply source. As illustrated, the rubber cover protects the connector when unused from external factors.

**Five-pin connector “OUTPUT”**

For output cable connection with clips, transmitting antenna or induction clamp. As illustrated, the rubber cover is removed for making external sources possible.



### 13.4. Accessories



**Output cable  
 («clips»)**

is designed for «contact» connection of the transmitter outlet to the communication under examination and earthing point



**Earthing rod**

is used as earth «return» of the electric current in case of «contact» way of connection to the communication under examination with the use of output cable (“clips”)



**External battery cable**

is designed for connection to the battery as the external power supply source. Clamp with red adhesive tape corresponds with the positive potential «+», the clamp with black adhesive tape relates to the negative potential «-»



*\*Extra accessories, optional*

**Induction transmitting antenna**

IEM-301.5 designed for “non-contact” connection of the device outlet to the communication under examination.



*\*Extra accessories, optional*

**Transmitting induction  
 “clamp”**

CI-105 is designed for highly efficient induction of the trace current to particularly “allotted” communication or for “non-contact” connection to the communication under voltage



*\*Extra accessories, optional*

**Mains power supply  
 adapter**

AG114M.02.020 (GS60A15-P1J «MEAN WELL»-based) is for the connection of the device to the mains with the voltage of 220V

## 11.5. Design and Function

There are many features that help any untrained operator master the device within a short period of time: convenient and user-friendly control and indication units with explanations, the elementary control algorithm backed by automation (“intuitive interface”) and several protection levels from emergency modes.

The automatic adjustment allows the generation of the specific signal current at the wide range of the load resistance. The transmitter can be connected to the load directly via connecting wires (“contact” way of connection) or by “non-contact” (induction) method, with the use of the internal transmitting antenna or with the extra accessories involved, for example, the external transmitting antenna or induction clamp.

The circuit solution of the power amplifier is implemented in the unique upgrade of the CLASS D technology and provides the highest degree of efficiency among all the known circuit design concepts for the power amplifiers. Thanks to the aforementioned, the relatively long “life-cycle” in the autonomous mode at such a high initial maximum output power is achieved, despite the light- weight and small size of the device.

The values of the output current set by the program at the automatic adjustment with the load of “occasional” resistance are optimum judge from the sensitivity of the majority of cable avoidance tools and are equal to 0.2A at “low” frequencies 512Hz “0.5” and 1024Hz “1.0” and 0.1A at “high” frequencies, 8192Hz “8.2” and 32768Hz “33”. During this, automatic adjustment load voltage incrementally increases until the moment when the values of the absorbed current and load current will not exceed the figures set by the program. If pre-set load current value is not achieved due to the high load resistance, then maximum possible output voltage is defined. Upon completion (or interruption by START/ STOP “

Under power supply voltage decrease during oscillation, for example, batteries self-discharge, the signal output voltage is lowering proportionally (and consequently absorbed power) as the supply source “energy potential” reduces. This program system extends the battery’s “life-cycle” considerably, therefore, while searching there is no premature “path loss” and the decrease of signal strength is offset by the wide range of options for the manual or automatic adjustment of the sensitivity of receivers made by «NPO TECHNO-AC» LLC.

### **WARNING! ENERGY SAVING!**

***All operations with output voltage (current and power) under connected load, lead to the changes of the energy consumption and consequently, “life-cycle” of the autonomous power supply. Watch the indicators of the power supply voltage “U” and absorbed current “I” in the electrical power supply field, so that there is enough time to perform utility location. In order to save energy, operate the device at the minimum sufficient load power. Always use “economy” pulse mode “Pu” when applicable. The operation breaks help to partially restore the capacity, therefore, net operating time with interruptions is always more than time of continuous operation, given all other conditions remain equal. The fall of environment temperature at the autonomous battery power supply has an adverse effect on the “life-cycle” of the power supply set (especially crucial at sub-zero temperatures). Always have a backup set of batteries.***

**NOTE**

While changing batteries, use only all 8 elements of “type C” produced by the same company, from same series and condition (all 8 cells are always operable or inoperable altogether). ALKALINE 1.5V batteries are recommended.

It is highly recommended to ensure that all 8 elements have approximately the same charge level. The assessment can be done with the help of direct-current voltage voltmeter, if all 8 elements are manufactured by the same company, marked with the same series and of the same condition.

If the batteries kit has undergone a full “life-cycle” in the “energy consuming” continuous mode “Co”, it is still likely to be used for quite a long time in economy” pulse mode “Pu” at “low” output power (up to 2 hours at the initial power of 5 W).

**11.6. Illustrative Use information about “Power Supply Monitoring”, “Buttons Functionality” and “Symbols”**

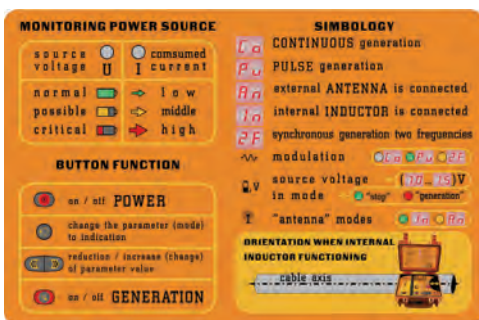

On the inner side of the cover, there is information on the principles of the following information types, namely POWER SUPPLY MONITORING, BUTTONS FUNCTIONALITY AND SYMBOLS of the “Digital field” and the front side of the panel.

**11.7. “Multimeter” of the Output Parameters**

In the “Digital field” during oscillation with the use of “clips” or “clamp”, the approximate values of the output parameters are indicated:

- load signal voltage in volts “**U, V**”
- load current “**I, A**”. Minimum measured and indicated value – 0.05A “.05”, current is indicated in Amperes (A).

**Examples:**

>than 0 and <50mA

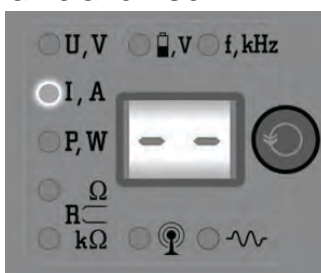

I < 50 mA

than 50mA and less than 99mA

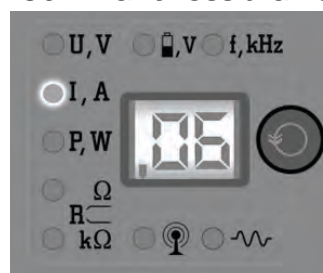

I = 60 mA

more 99mA





I = 0,2 A

- load power in watts “**P, W**”;
- load resistance in ohms or kilohms “**R, (Ω / kΩ)**”. In “antenna” modes “In” or “An” only “U, V” is indicated (output signal voltage applied to the antenna). The accuracy of measurements is enough for situation assessment at load resistance up to 800Ω. The parameter which value should be indicated in the “Digital field” is set by the “CHOICE” button “” in the “Output parameters field” immediately during oscillation process.

## 11.8. Sound Signals

The sound signals correspond with the specific events and conditions.

**Welcome tune** consists of 9 notes activated by the device switching on via pressing POWER “” button.

**High note** while pressing CHOICE “” button during the automatic adjustment – the relevant action took place.

**High note** while pressing MORE “” button — the increase (alteration) of the parameter value (mode).

**Low note** while pressing LESS “” button — the decrease (alteration) of the parameter value (mode).

**Very low note** by pressing one of the buttons LESS / MORE “” - the action is not allowed by the program.

**Double note** signal by pressing CHOICE “” button in the “stop” mode – the relevant action took place.

**Dual sound** signal by pressing START / STOP “” – initiation or shutdown of the oscillation.

**Triple note** signal by pressing START / STOP “” - the manual interruption of the automatic adjustment.

The **sequence of the rising notes ending with the triple note signal** – the full cycle of the automatic adjustment.

**Double note sequence (“siren”)** - output current overload.

**Sequence of the triple note “alarms”** – hardware current safety system activation

**Sequence to the quadruple note “alarms”** – power supply voltage is unacceptably low.

**Quick sequence of the similar high note** — power supply voltage is unacceptably high.

**Farewell phrase** consists of the three falling notes during manual shutdown of the device by the pressing POWER “” button.

## 12. Working with the Device

**Prior to the “contact” connection, it is necessary to make sure that the utility under examination has no voltage to “earth” and also that there are no works carried out or scheduled to be conducted, which execution can lead to deliberate or accidental contact with conductive part which is under the voltage. If the examination of cable under voltage is required, one should use “non-contact” method of connection with the help of the transmitting antenna or induction clamp.**

**WARNING! Do not touch terminals of output connection cables and elements of the utility being examined while the transmitter is on.**





**WARNING! Do not connect and disconnect connection cables while the transmitter is on.**

**WARNING! Do not connect and disconnect connection cables while the transmitter is on.**

### 12.1 Preparatory activities

12.1.1 Remove the battery set by simply pulling up by the handle and insert 8 power supply elements into it, observing the polarity (batteries or NiMh accumulators). Put the battery set back.

12.1.2 When the transmitter is being turned on, it indicates the type of power supply. In order to change the type of power supply, you have to turn on the transmitter holding “” button.

After that, you can switch the type of power supply by pressing “” and “”. You can choose between battery “” or accumulator “”.

To confirm your choice of power supply type, press start button “”.

**NOTE: Using the accumulators without corresponding transmitter setting, may cause their malfunction.**





12.1.3 Choose the load type from the options:

- **“clips”** (connect “output cable” to the connector “OUTPUT” on the back panel);
- **internal transmitting inductor “In”** (no connections allowed to the “OUTPUT” connector on the back panel);

12.1.4 Connect the output of the device to the utility under examination via contact or non-contact (induction) method (in accordance with the chosen utility locating method). The contact method is more efficient for utility location but not always convenient and absolutely unsuitable for the location of cables which are “under voltage”.

**NOTE:**

In the article, only classical methods of “contact” and “non-contact” connection are represented in various circumstances. Special connection options such as “conductor-conductor”, “conductor-armour”, “armour-earth”, “parasitic capacity of unconnected multi-conductor cable” and others used under the specific conditions and only for “flaw detection” are considered in the “utility locating methods” indicating in the descriptions of the utility locators.

**1) Base Method of the “Contact” Connection to the Utility**

The “clips” are used (“output cable” with “alligator” clips) and earth rod. One clip should be connected to the input of the utility under examination and the second one to the earth rod (or to the relevant earthing, for example, standard earthing bus) at maximum distance from the utility. It is essential to provide close contact with utility and Earth. The opposite end of the utility under examination should be earthed for creating the paths for earth return of the signal revocable current. If the transmitter is connected directly to the utility, and current is not indicated (you see “- -” on the screen), make sure that there is current in the utility by checking it with receiver.

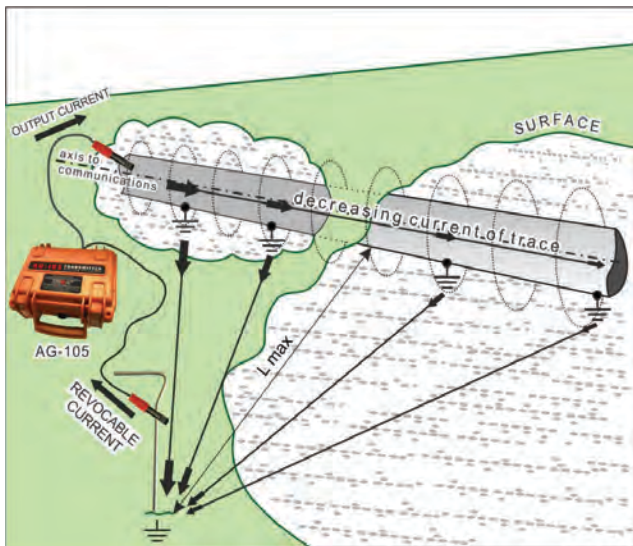

Special option – bare PIPE IN THE GROUND. The ground contact is possible along the entire length of the utility and in any segment. The additional earthing of the pipe is useless.

In this case, the resistance between the connection to the pipe and earthing point (rod or other standard earthing bus) is extremely low. “Revocable” current is reduced considerably the farther the location from the connection point. Nevertheless, owing to the unique (for this type of devices) “reserve” of the output current (more than 5 A at the load less than 0.8Ω), it offers high

probability of the successful utility location at a considerable distance from the connection point.

The diminishing of the signal at the distant pipeline sections is offset by the considerable “reserve” for the manual or automatic adjustment of the sensitivity of receivers made by TECHNO-AC.

**NOTE** for “non-contact” connection methods (“In” / “clamp”)

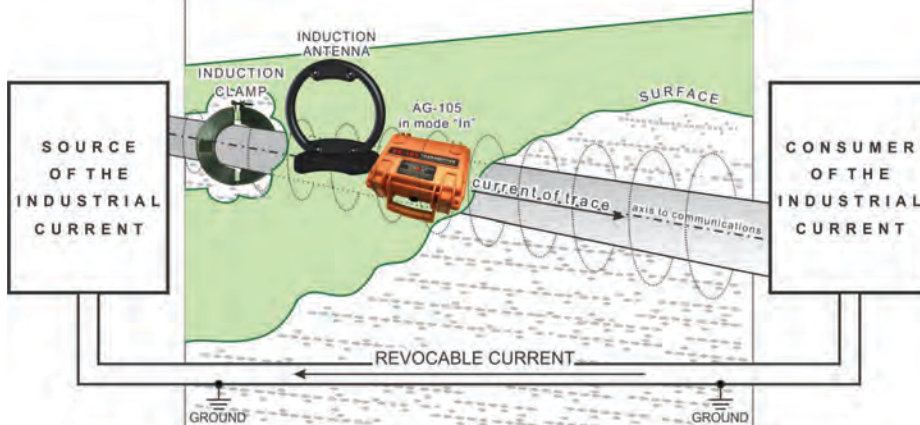

If the utility forms part of the complete electrical circuit “source – utility – consumer” (as per illustration), then in case of the specific electric properties of these chain loops, the location of a utility via the “non-contact” connection method (“In” / “An” / “clamp”), is quite likely without additional earthing.

In this example, “revocable” signal current of “high” frequency (0.5...33kHz), “overlaps” the current of “low” (industrial) frequency (50 / 60Hz) which is not preventing from the location of the utility and the flow path for “revocable” current of the signal already provided.

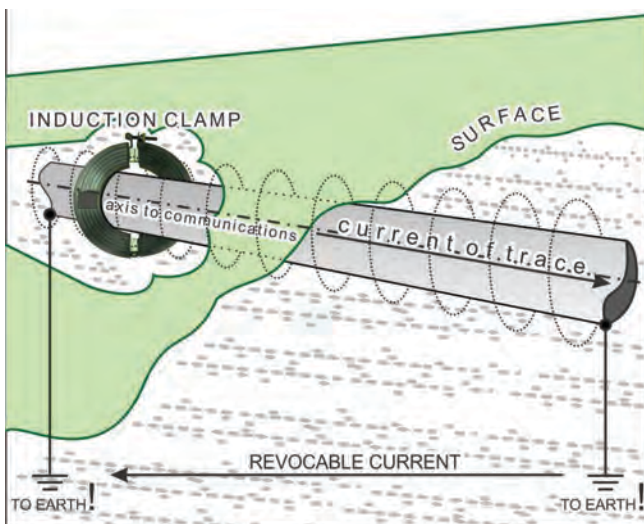
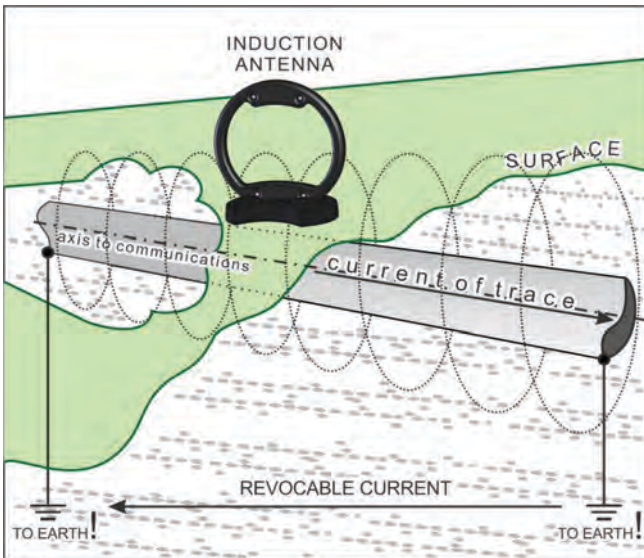
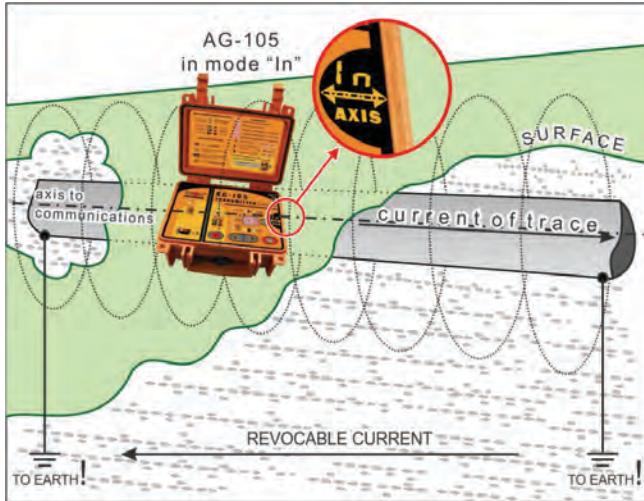

**2) If the internal transmitting inductor is in use,** then the casing of the device should be located right above the utility under examination (to set the reference point “In axis” on the front panel above the axis of the communication and oriented parallel to its direction). The utility locator shouldn’t be used near to the transmitter location in order to avoid the immediate induction connection (apart from the utility).

If the utility is not a part of the complete electrical circuit then both its ends should be earthed for creating a path for earth current “return” of the signal.

**3) If the external induction transmitting antenna is in use “An”** then it should be located as close as possible to the examined communication and coplanar with it. The communication locator shouldn’t be used nearby the transmitting antenna in order to avoid the immediate induction connection (apart from the communication).

If the communication is not a part of the complete electrical circuit then both its ends should be earthed for creating a path for earth current “return” of the signal.

The earthing should be done at a possible distance from the communication to reduce mutual cancellation of the “tracing” and “revocable\return” signal current.

**4) If the induction transmitting “clamp” is in use** then the utility should be wrapped by them in any available point. The utility locator shouldn’t be used near the “clamp” location in order to avoid the immediate induction connection (apart from the utility), despite the fact that in this case, this connection is not as evident as in the “antenna” mode “In”.

If the utility is not a part of the complete electrical circuit, then both its ends should be earthed (for creating a path for earth “return” of the “revocable” current signal). The earthing should be done at a possible distance from the utility to reduce mutual cancellation of the “tracing” and “revocable\return” signal current.

## 12.2. Settings

12.2.1 Open the cover. Turn on the device by pushing POWER “**I**” button.

12.2.2 After switching on of the device “on default” the indicator POWER SUPPLY VOLTAGE “**V**” glows green. The device is in the “stop” mode. The pre-set of the modes and parameters values should be done.

12.2.3 If it is necessary to change the indicated mode or parameter, it can be done by sequenced presses of the CHOICE “**O**” button.

In this case (“along the loop” and “counterclockwise”) in the “Internal parameters field” and “Modes field” one can choose reference and variable values of the modes and parameters indicated in the “Digital field”. The chosen mode and parameter marked by the flash of the relevant indicator.

The sequence of the indications in the functional fields.

- 1) “**V**” - POWER SUPPLY VOLTAGE in volts (reference value, **green** glow);
- 2) “**I**” - active “ANTENNA” mode and the type of connected transmitted antenna (depends on which accessory is connected to the “OUTPUT” connector:
  - 3) “**~**” - active / non-active “MODULATION” and the type of the special signal form (should be chosen in the “Digital field” by MORE/ LESS “**◀▶**” buttons):
    - lack of glow – no modulation (continuous signal “**Co**” “of standard” sin form).
    - **green** glow – pulse modulation mode “**Pu**”.
    - **yellow** glow – dual-frequency modulation mode “**2F**”.
  - 4) “**f, kHz**” - frequency of the generated signal in kilohertz (**green** glow) is chosen in the “Digital field by LESS/ MORE “**◀▶**” buttons:
    - for loads “clips” or “clamp” - 512Hz “0.5” / 1024Hz “1.0” / 8192Hz “8.2” / 32768Hz “33”.
    - for “antenna” modes “In” or “An” - 8192Hz “8.2” / 32768Hz “33”.

The generation frequency is set if possible lower but according to recommendations of the chosen utility location method and proceed from the premise that the lower the frequency:

- the less re-inducing to the nearby facilities, the less the leakage of the “revocable” current, the more transmission distance.
- the lower sensitivity of the utility locators (more revocable current required and consequently power of transmitter). The more difficult to overcome the communication conductivity flaws.

## 12.3 Clips(standard accessory for the “contact” connection)

12.3.1 If clips/earrings are connected to the “OUTPUT”, the device is ready for “contact” load connection. The internal transmitting inductor “In” is not connected (“ANTENNA” mode indicator “**I**” does not glow).

12.3.2 To connect, put one clip to the input of the examined utility and the second one to the earthing rod (or relevant earthing) at maximum distance from the utility. The opposite end of the examined utility should be earthed.

12.3.3 By pressing the button START/STOP “**▶**” is initiated the automatic adjustment process with the “occasional” resistance load. Along with this, the output signal voltage incrementally increases up to the moment when the specific load current value is reached (or exceeded) (0.2A at frequencies 512Hz “0.5” / 1024Hz “1.0” / “2F” or 0.1A at frequencies 8192Hz “8.2” / 32768Hz “33”). If the load resistance is too high for reaching these values of the output current, then the maximum possible output signal voltage is produced.



12.3.4 After that, manual alterations (by LESS/MORE “**◀▶**” buttons) of the output signal voltage are possible in the range of provided by the automation.





## 12.4. Internal transmitting inductor “In”



12.4.1 The internal transmitting inductor is connected to the output automatically if there are no other accessories connected to the “OUTPUT” connector “Antenna” mode “In” is indicating (“” - **green**).

12.4.2 For maximum intensity of “inducing” the reference point of the emitting inductor (“In axis” on the front panel) should be placed above the utility axis and in its direction.

12.4.3 In the “ANTENNA” mode “In” (via buttons LESS / MORE “ ”) the FREQUENCY of the generated signal can be chosen “f,kHz”: 8192Hz “8.2” / 32768Hz “33”.

12.4.4 In the “ANTENNA” mode “In” besides of the “regular” continuous oscillation mode “Co” (by pressing LESS / MORE “ ”) buttons) pulse “MODULATION” “Pu” is available for choosing.

12.4.5 The oscillation is activated by START / STOP “” button. Upon completion of the automatic adjustment, the highest value of signal voltage is reached on the output “U,V”  $\geq$  “40”.

12.4.6 After that, manual decrease and inverse increase of the signal voltage (by LESS / MORE “ ”) buttons) in the range envisaged by the automation.

## 12.5. External power sources

To the EXTERNAL SUPPLY, connector on the back panel can be connected an “appropriate” power source currently possessed by the customer.

Mains power supply adapter AG114M.02.020 (based on GS60A15-P1J “MEAN WELL”) energises from the mains with the voltage of 220V and supply a direct-current voltage of 15V  $\pm$  3% with value of the current being 4 A. Offered as an extra accessory.



In the case of the availability of two power sources at the same time – external and internal

(battery) – the device consumes supply current from the source which has the larger value of output voltage. Therefore, in the case of external power, it is recommended to remove the battery (at least one) in order to avoid their possible useless charge consumption.



## 12.6. Electromagnetic Compatibility

The present device is subsumed under “information technology equipment” (ITE) class A, according to Russian Stage Standard (GOST) 51318 22-2006. Such equipment should not have any sale restrictions. When used in private households, this equipment could disturb the smooth running of other technical equipment because of the industrial interferences. In this case, the user should act accordingly.

### NOTE

A private household is a space where the radio and TV sets can be placed at a distance less than 10m from ITE.

## 12.7. Ingress Protection Rating

The ingress protection rating of the casing is IP65, which completely eliminates the possibility of the ingress of dust and water jets inside when the device is lidded. Open slots on the back panel are protected by rubber covers.

### 13. Transmitter Direct Connection to Utility

The direct connection of transmitter to the utility is used to create tracing current in de-energised conducting utilities.

**Transmitter operation during direct connection requires additional safety precautions. Before connecting the transmitter directly to the utility do the following:**

- 1) **Make sure that surveyed utility doesn't carry any voltage in relation to protective grounding or grounding rod, pushed into the ground.**
- 2) **Make sure that there is no high voltage source connected to the utility.**
- 3) **Make sure that there is no 15V voltage between transmitter cable connection points.**

Use the multimeter to check the voltage presence between connection points.

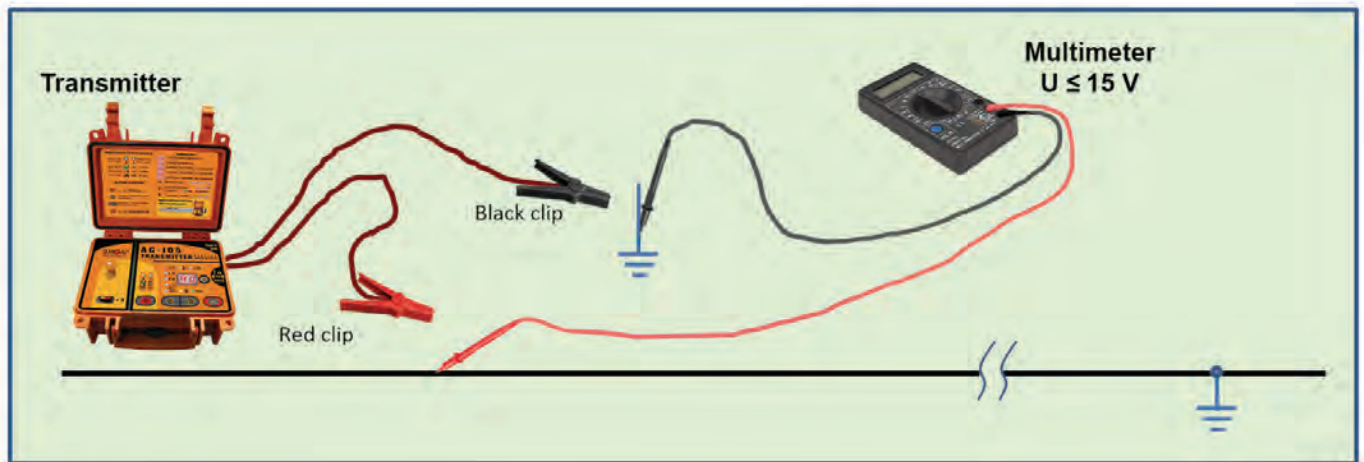

**Attention!**

**Voltage between two points of transmitter cable connection can damage the transmitter!**



**Connection of the transmitter to utility under voltage, breaks the operation conditions and cancels manufacturer warranty!**

If it is necessary to survey the cable under voltage, please, use inductive antenna or clamps for the transmitter in order to create tracing signal.

## Appendix 5

### Transmitter AG-105 Technical specifications

<b>The frequencies of the continuous “Co” or pulse “Pu” signal, Hz ± 0,1% - “kHz”</b>	
Load “clips” or “clamp”	<b>512</b> - “0.5” / <b>1024</b> - “1.0” / <b>8192</b> - “8.2” / <b>32768</b> - “33”
“Antenna” modes	<b>8192</b> - “8.2” / <b>32768</b> - “33”
<b>Operating modes</b>	
“Antenna” mode	Internal transmitting inductor “In”.
“Modulation” modes (special form signal)	Pulse “Pu” (short-term transmissions of the sine signals). Transmission duration 0,12sec. Transmissions repetition frequency 1Hz.
	Dual-frequency “2F” (simultaneous frequency generation 1024Hz, 8192Hz). Amplitudes ratio 4/1 (respectively).
<b>Output parameters under power supply voltage 12...15V</b>	
<i>Output current, A</i>	
Restricted by the program <b>under manual increment</b> , ≥	<b>5</b> – at frequency 512Hz “0.5” / 1024Hz “1.0” / 8192Hz “8.2” / “2F”
	<b>3</b> - at frequency 32768Hz “33”
Set by the program for <b>automatic adjustment</b> with the external load of “clips” or “clamp”, ≥	<b>0,2</b> – at frequency 512Hz “0.5” / 1024Hz “1.0” / “2F”
	<b>0,1</b> – at frequency 8192Hz “8.2” / 32768Hz “33”
<i>Maximum output voltage, V</i>	
Depending on “modulation”, ≥	<b>32</b> – in the dual-frequency modulation mode “2F”
	<b>40</b> – in other modes
<i>Maximum output power, W</i>	
Restricted by the program, ≥	<b>20</b> - In the continuous “Co” and pulse “Pu” modes at frequencies 512Hz “0.5” / 1024Hz “1.0” / 8192Hz “8.2” at load resistance up to 80Ω In dual-frequency mode “2F” at load resistance up to 50Ω.
	<b>6</b> - At frequency 32768Hz “33” at load resistance up to 260Ω.
<b>Power supply sources</b>	
Operating range of the supply <b>voltages</b>	Minimally acceptable voltage for oscillation start-up: <b>7V</b> “Bt”, <9 V “Ac”
	Maximum allowed voltage for operation – <b>15V</b> .
	Automatic shutdown voltage in the “oscillation” mode: < <b>4,2V</b> “Bt”, <7,9 V “Ac”
<b>Battery</b> set	8 “alkaline” cells 1,5V “type C” Recommended – “Duracell® ULTRA”.
<b>External</b> power supply sources (optional)	<b>Battery</b> “12V” (e.g. automotive) Output voltage 11...14V, maximum current not less than 4A.
	<b>Mains power supply adapter</b> AG114M.02.020 (extra accessory based on GS60A15-P1J “MEAN WELL”) Output voltage 15V, power 60W.
<b>Operating time (“life cycle”)</b>	While in operation of the battery set “type Cx8” is defined by the quality (capacity and “load capability”) of the applied alkaline cells and can be equal to <b>from 4 to 6 hours in the “Co” and “2F” modes or from 20 to 30 hours in the “Pu” mode</b> at initial output voltage 7W in “continuous” modes “Co” / “2F” or at initial output voltage 15W in pulse modulation mode “Pu”
	Under the external power supply is fully conditioned by this external energy source characteristics therefore <b>under mains supply operating time is unlimited.</b>

<b>Operational characteristics</b>	
An automatic <b>control over the output voltage</b> during oscillation process	Proportional control over the output power depending on the “energy potential” of the power supply source.
Automatic <b>shutdowns</b> of the device	At power supply voltage in the “stop” mode < 6.5V “Bt”, <8.8V “Ac”
	At power supply voltage in the “oscillation” mode < 4,2V “Bt”, <7.9V “Ac”
	At power supply voltage > 15,5V.
	In case of exceeding of the admissible absorbed current value (the exact figure depends on the actual mode)
	In case of short circuit of the output during the adjustment process (actuation of the hardware safety system of the terminal amplifier)
	In case of non-compliance of the oscillation mode settings depending on whether the external antenna is installed in the output or not (the switch to the “stop” mode)
	In case of “long” ( $\approx 100$ sec) downtime in the “stop” mode (if the buttons are not pushed)
Adjustment with load	<b>Automatic</b> , up to the reaching of the specific consumption rate or attainment of the load current: - $\geq 0,2$ A at frequencies 512Hz “0.5” / 1024Hz “1.0” / “2F”; - $\geq 0,1$ A at frequencies 8192Hz “8.2” and 32768Hz “33”.
	<b>Manual</b> (via buttons LESS / MORE “   ”) after the automatic adjustment.
<b>Connection options</b> to the communication under examination	“Contact” connection with “earth return”.
	“Non-contact” connection with application of the internal transmitting antenna “In”.
	“Non-contact” connection using the transmitting induction “clamp” (selection of the cable from the bunch as possible).
<b>Electromagnetic compatibility</b>	
<b>Classification</b> in accordance with the Russian State Standard (GOST) 51318.22-2006	Class A
<b>Structural parameters</b>	
<b>Power output amplifier</b>	The technology — updated <b>CLASS D</b> <b>Efficiency to 85%</b>
LED <b>indicators</b>	Separate light-emitting diodes indicating parameters and modes.
	Digital indicator displaying the modes and parameters values and also showing output parameters of the “ <b>MULTIMETER</b> ” measurements, e.g.: output voltage (V), load current (A), load power (W) and load resistance ( $\Omega$ /k $\Omega$ ).
<b>Overall dimensions</b> of the electronic unit (case), not more than, mm.	<b>216x180x105mm</b>
The <b>weight</b> of the electronic unit, not more than, kg	<b>2</b>
The admissible environment <b>temperatures range</b> when in operation	<b>- 30...+60°C</b> With “battery” power supply it is not recommended to use the device under sub-zero environmental temperatures.
<b>Ingress protection rating</b>	IP65 (when the enclosure-case is shut).

## Appendix 6 Transmitter Indication

**Battery holder**  
with the handle in the centre for removing. Contains 8 alkaline cells 1,5V "type C".

**Electrical power supply field**  
One of the three categories of power source VOLTAGE "U" and ABSORBED CURRENT "I" is always displayed by the glow of one of the three-coloured indicators.

**Output parameters field**  
VOLTAGE "U, V", CURRENT "I, A" and load POWER "P, W" and also its RESISTANCE "R, Ω / kΩ". The only possible **red** glow of indicators of this field means "oscillation" is in progress.

**Internal parameters field**  
POWER SUPPLY VOLTAGE "U, V" and FREQUENCY of the generated continuous "Co" or pulse "Pu" signals "f, kHz".  
**Green** glow of POWER SUPPLY VOLTAGE indicator "U, V" can be seen in the "stop" mode, **red** - in "oscillation" mode.

**Internal induction transmitting antenna field "In"**  
In "antenna" mode "In" the orientation mark "In axis" should be positioned precisely above utility axis and oriented parallel to its direction.

**CHOICE button**  
By sequenced presses MODE or PARAMETER indication can be chosen to be shown on the "Digital display".

**START/STOP button**  
The sequenced presses are switching the device from "STOP" mode to "OSCILLATION" and back.

**Digital display**  
shows NUMERICAL value of the parameter ("U, V" / "f, kHz" / "U, V" / "I, A" / "P, W" / "R, Ω / kΩ") and SYMBOLIC notation of the mode ("In" - internal transmitting inductor/ "An" - external induction transmitting antenna/ "Co" - continuous oscillation mode/ "Pu" - pulse modulation mode. Type of the displaying value is defined by the CHOICE button.

**Modes field**  
has indicators of "ANTENNA" "In" and "MODULATION" "Pu" modes. If "earrings" or "clamp" are connected to the output, the indicator "In" not glowing. In "Antenna" mode, the indicator "In" is always glowing: **green** in case of internal antenna. In case of "regular" (not modulated) signal the indicator "Pu" is not glowing. In case of "MODULATION" (special form signal) the indicator "Pu" always glows: **green** in pulse mode "Pu".  
*Therefore, current operating mode is always displayed in the "modes field".*

**POWER button**  
on /off switching of the electric power supply

**LESS/MORE buttons**  
Decrement / increment (adjustment) of the chosen (mode) or parameter value.

<b>INDICATION EXAMPLE</b>				
"nominal" power supply voltage	"low" absorbed current	pulse modulation mode "Pu"	"oscillation" operation mode	output voltage 40V
"U" <b>green</b>	"I" <b>green</b>	"Pu" <b>green</b>	<b>red</b> glowing "U, V"	"U, V" → "40"